

TUBI INDUSTRIALI PER USO NAVALE ED IMBARCAZIONI DA DIPORTO

MARINE INDUSTRIAL HOSES





CONNECT.SUPPORT.CONVEY

Da quasi 60 anni, Sati Group produce e distribuisce nastri trasportatori in gomma, tubi industriali in gomma e PVC, lastre e tappeti in gomma.

Since 60 years, Sati Group produces and distributes rubber conveyor belts, industrial rubber and PVC hoses, rubber sheeting and foam rubber.

Puntiamo da sempre sull'affidabilità del servizio, la prontezza delle consegne, la costante disponibilità a magazzino di oltre 5.000 articoli di alta qualità, oltre a un servizio personalizzato e su misura che ci consente di gestire oltre 2500 ordini al mese. Quasi sessant'anni di storia non si improvvisano. In un contesto internazionale sempre più competitivo, il patrimonio di esperienze accumulato in decenni di successi sui principali mercati internazionali ci ha insegnato l'importanza di ascoltare i clienti per intuirne in anticipo le esigenze e rispondere con efficacia anche nelle situazioni più complesse. La ricerca di nuove soluzioni è parte integrante del nostro DNA.

Da sempre cerchiamo in tutto il mondo prodotti di qualità superiore, in grado di migliorare le prestazioni e l'efficienza di ogni tipo di processo industriale. Investiamo in sviluppo, progettando e realizzando soluzioni e prodotti innovativi come le nostre linee di produzione SATIVERTICAL (nastri trasportatori bordi e tazze) e SATIFOAM (materiali espansi) in grado di fare la differenza per prestazioni e durata.

Il nostro headquarter di Castel Maggiore si estende su una superficie coperta di oltre 30.000 mq ed è dotato della più avanzata impiantistica per la produzione, l'assemblaggio e la movimentazione di tutti gli articoli a catalogo. Il nostro obiettivo è assicurare il massimo di efficacia produttiva ed efficienza logistica al cliente nel rispetto della sicurezza e del benessere di tutto il nostro team.

Our efficiency is based on reliability, rapid deliveries, the availability of over 5000 high quality products in stock and the tailor made service that allow us to handle over 2500 orders every month. Almost sixty years of history have taught us the importance of listening to our customers in order to understand their needs and to provide support in handling complex procedures and special orders. The searching of new solutions is in our DNA.

We try to find all over the world high quality products in order to increase the efficiency of every industrial process. We invest in development and we realize innovative solutions and products such as our SATIVERTICAL (sidewalls and cleats belts) and SATIFOAM (foam materials) production lines.

Our headquarter based in Castel Maggiore occupies an area of over 30,000 square meters and it is equipped with the most advanced production, assembly and handling systems. Our goal is to ensure the best logistic and production efficiency for our customers in full respect for the welfare of our team.



La nostra forza risiede anche nella sede centrale di cui disponiamo: 30.000 m² di magazzino e oltre 500 m² di uffici ci permettono di avere oltre 5000 articoli in pronta consegna e, di conseguenza, di gestire puntualmente oltre 2400 ordini clienti al mese.

Our strength also lies in our main base, where we have 30,000 sqm of warehouse and 500 sqm of office space, enabling us to offer more than 5,000 items ready for delivery and therefore to efficiently handle over 2,400 orders every month.



La logistica che funziona.
Logistics that work.

INDICE INDEX



FUEL TUBI PER OLIE CARBURANTI OIL AND FUEL HOSES

6

CARBOMARINE / LN 10	6
CARBO ECO	7
CRISTALBENZ	8
PRESSCORD GREEN FUEL	9
CARBOMARINE / SP	10
CARBOMARINE / SP-C	11
CARBOMARINE / IT	12
GRECATO / SP MULTIPURPOSE	13



EXHAUST TUBI PER SCARICO GAS COMBUSTI EXHAUST HOSE (*)

14

MARINGAS / SP	14
SILMARINE / SP	15



SANITARY USO SPECIFICO SCARICO WC SPECIAL WC

16

SANITARI / WC ULTRAFLEX	16
CORDSTEEL / WC	17
SANISTEEL / WC	18



MULTIPURPOSE & BILGE PUMP USO SCARICO ACQUA WATER SUCTION & DELIVERY HOSE

19

CORDSTEEL P.L.	19
CORDFLEX N.T.	20



SEA WATER-HOT WATER TUBI PER ACQUA DI MARE, ACQUA CALDA E VAPORE / SEA WATER, HOT WATER AND STEAM HOSES

21

EPDM / LN 10	21
ACQUA CALDA / 120°C	22
WATER INTAKE / SP	23
RADIATOR	24



FOOD GRADE USO SPECIFICO MANDATA ACQUA WATER DELIVERY HOSES

25

CRISTALCORD	25
BOILER LDPE LR/LB	26
EPDM FQ	27

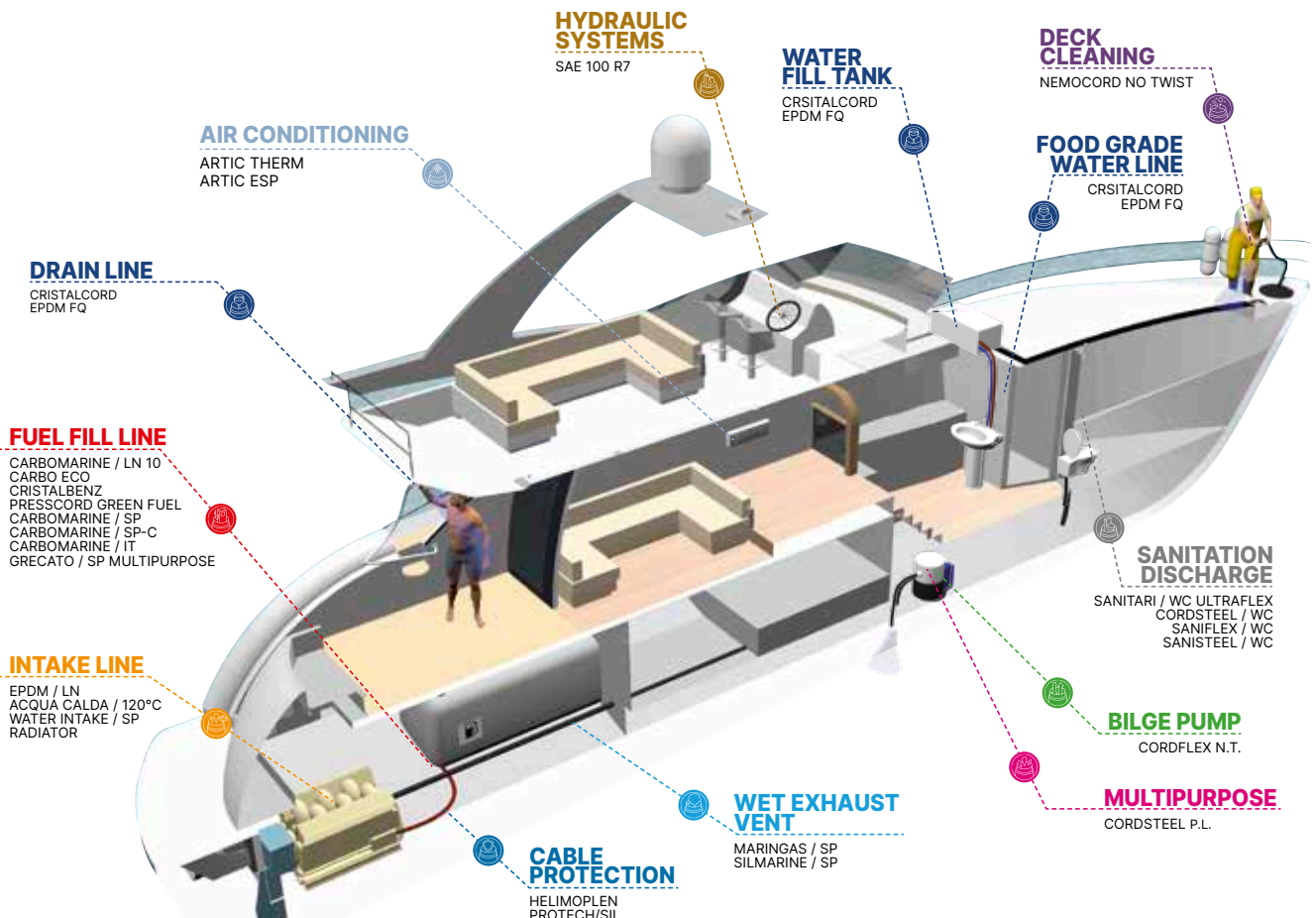

 **AIR & FUME DUCTING**
USO SPECIFICO EVACUAZIONE FUMI
VACUUM HOSE **28**

CORDFLEX AIR	28
THERMOCORD HL	29
THERMOCORD 130°C	30

 **DECK CLEANING**
USO SPECIFICO LAVAGGIO
CLEANING HOSE **31**

NEMOCORD	31
----------	----

 **CONDITIONING**
CONDIZIONAMENTO
AIR CONDITIONING **32**

ARTIC / ESP antibatterico	32
ARTIC THERM	33

 **CABLE PROTECTION**
GUAINE DI PROTEZIONE
CABLE PROTECTION **34**

PROTECH / SIL	34
HELIOMPLEN	35

 **HYDRAULIC SYSTEMS**
USO SPECIFICO SERVOSTERZO
POWER STEERING **36**

SAE 100 R7	36
------------	----

 **SATIBLOCK®**
FASCETTE E COLLARI STRINGITUBO
CLAMPS AND COLLARS **37**

STF W1 Hose clamps with screw	38
STF W2 Hose clamps with screw	39
STF W4 Hose clamps with screw	40
STF W4 HEAVY DUTY Hose clamps with screw	41
STF W5 Hose clamps with screw	42
STC W2 Hose clamps with bolt	43
STC W4 Hose clamps with bolt	44
STC W5 Hose clamps with bolt	45
MAGNUM W2 Hose clamps with bolt	46
MAGNUM W4 Hose clamps with bolt	47
STM Hose clamps	48
STS Constant tension clamps SAE type "T"	49
SDB Dual bead clamp SAE type "F"	50
SGT Step less	51
SBS Double wire screw	52
SBV Double wire screw	53
SSS Spiral piepe clamp	54
SCG Rubber clamps	55
BANDI BLOCK Tightening Torque	56



(*) HOMOLOGATED
RINA and LLOYD'S

NMMA®
National Marine
Manufacturers Association

SIMBOLI / SYMBOLS / SYMBOLE / SÍMBOLOS / SYMBOLES

 DIAMETRO INTERNO INSIDE DIAMETER DIAMETRE INTERIEUR INNENDURCHMESSER DIÁMETRO INTERNO	 PRESIONE D'ESERCIZIO WORKING PRESSURE PRESSION DE SERVICE BETRIEBSDRUCK PRESIÓN DE TRABAJO	 PESO WEIGHT POIDS GEWICHT PESO	 TEMPERATURA D'ESERCIZIO WORKING TEMPERATURE TEMPERATURE DE TRAVAIL BETRIEBSTEMPERATUR TEMPERATURA DE TRABAJO
 DIAMETRO ESTERNO OUTSIDE DIAMETER DIAMETRE EXTERIEUR AUSSENDURCHMESSER DIÁMETRO EXTERNO	 PRESIONE DI SCOPIO BURST PRESSURE PRESSION D'EXPLOSION BERSTDRUCK PRESIÓN DE ROTURA	 RAGGIO DI CURVATURA BENDING RADIUS RAYON DE COURBURE BIEGUNGSRADIUS RADIO DE CURVATURA	 COLORI COLORS
 SPESORE PARETE WALL THICKNESS EPAISSEUR DE PAROI WANDSTÄRKE ESPESOR	 ASPIRAZIONE VACUUM ASPIRATION VAKUUM ASPIRACIÓN	 LUNGHEZZA LENGHT LONGUEUR LANGE LONGITUD	ALTRI DIAMETRI O PRESSIONI REALIZZABILI SU RICHIESTA. Le caratteristiche e i dati tecnici possono essere modificati senza preavviso. OTHER DIAMETER AND/OR PRESSURE REQUIREMENTS ARE AVAILABLE UPON REQUEST. The characteristics and technical data are subject to modification without prior notification.



MARCATURA / MARKING / MARQUAGE / BESCHRIFTUNG / MARCATURA

EUROCORD®

EN ISO 7840: 2021
COMPATIBLE R.I.N.A APPROVED - CE - YEAR -
SAE J 1527:2011 USCG R1 - LLOYD'S APPROVED



• **EXTRA FLEXIBLE**

• **HOMOLOGATED**



IMPIEGO / USE / EMPLOI / EINSATZ / EMPLEO

Tubo idoneo per adduzione di carburanti diesel e benzine ecologiche nelle imbarcazioni e navi da diporto. Tubazione estremamente flessibile e leggera con ottimi raggi di curvatura. **Omologato R.I.N.A** secondo Direttiva Europea 2013/53/UE - ISO 7840: 2021 - A1 e LLOYD'S.

Ideal for the delivery of fuel such as diesel and unleaded gasoline for marine craft, extra flexible and light weight hose with very low bending radius. **R.I.N.A approved, according to Directive 2013/53/EU - ISO 7840: 2021 - A1 and LLOYD'S.**

Idéal pour le refoulement des carburants tels que diesel et essences écologiques pour navires et bateaux de plaisance. Tuyau extrêmement flexible et léger aux rayons de courbure très réduits. **Homologué R.I.N.A. selon Directive 2013/53/UE - ISO 7840: 2021 - A1 et LLOYD'S.**

Geeignet für die Adduktion von ökologischen Diesel- und Benzinkraftstoffen für Booten und Schiffen für die Sportschiffahrt. Extrem flexibler und leichter Schlauch mit optimalem Biegungsradius. **Genehmigt R.I.N.A, Ander. Richtl 2013/53/EU - ISO 7840: 2021 - A1 und LLOYD'S.**

idónea para la entrega de carburantes como diesel y gasolinas ecologicas para barcos y embarcaciones de recreo. Manguera extremadamente flexible y ligera por medio de radios de curvatura muy bajos. **Homologada R.I.N.A. segundo Directiva 2013/53/UE - ISO 7840: 2021 - A1 y LLOYD'S.**

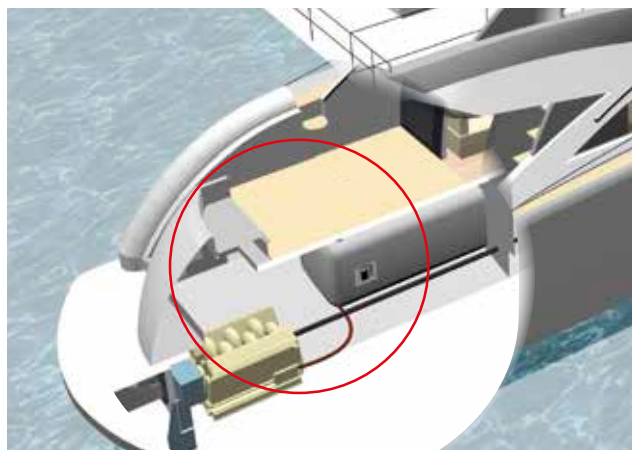

**STRUTTURA / STRUCTURE / STRUCTURE
STRUKTUR / ESTRUCTURA**

SOTTOSTRATO

INNER LAYER
COUCHE INTÉRIEURE
SCHLAUCHEINLAGE
CAPA INTERIOR



Liscio in gomma nera (NBR) resistente ai carburanti con contenuto aromatico non superiore al 50%.
Black (NBR) rubber, smooth, oil resistant to fuel with maximum 50% aromatic content.
Lisse en caoutchouc noir (NBR) résistante aux carburants au contenu aromatique non supérieur de 50%.

Glatt aus schwarzem kraftstoffbeständigem Gummi (NBR) mit einem Aromagehalt, der 50% nicht übersteigt.

Lisa en caucho negro (NBR) resistente a los carburantes con contenido aromático no superior de 50%.

INSERTI

REINFORCEMENT
RENFORCEMENT
EINLAGEN
REFUERZOS



Tessili, sintetici ad alta tenacità.
Synthetic textile high tenacity yarns.
Gaines textiles synthétiques de haute ténacité.
Synthetisches Gewebe mit hoher Reißfestigkeit.
Hilos textiles, sintéticos de alta tenacidad.

COPERTURA

OUTER COVER
COUCHE EXTERIEURE
AUSSENSCHICHT
CAPA EXTERIOR



Mescola in gomma sintetica resistente alla fiamma, ai lubrificanti, ai carburanti all'abrasione, all'acqua di mare ed agli agenti atmosferici. **Superficie: liscia.**
Synthetic rubber compound flame resistant, also to lubricants, oil, sea water and weathering conditions. **Outer layer: smooth.**
Mélange en caoutchouc synthétique, anti-flammes, résistant aux lubrifants, aux carburants, à l'abrasion, à l'eau de mer et aux agents atmosphériques. **Couche extérieure: lisse.**
Verbindung aus synthetischem Gummi; beständig gegen Flammen, Schmiermitteln, Treibstoffen, Abrieb, Meerwasser und Witterungseinwirkungen. **Oberfläche: glatt.**
Mezcla en caucho sintético, anti-llamas, resistente a los lubricantes, a los carburantes, a la abrasión, al agua de mar y a los agentes atmosféricos. **Capa exterior: lisa.**

mm	mm	bar	bar	bar	g/m	mm	mt
5	15	-	>14	-	0,210	50	40
6	16	-	>14	-	0,240	60	40
8	17	-	>14	-	0,240	80	40
10	19	-	>14	-	0,280	100	40
12	22	-	>10	-	0,300	120	40
16	26	-	>10	-	0,460	160	40
19	30	-	>10	-	0,590	190	40

IMBALLO: polietilene blu **PACKAGING:** Blue polyethylene **EMBALLAGE:** polyéthylène bleu **VERPACKUNG:** blaues Polyethylen **EMBALAJE:** polietileno azul



Disponibili anche in rocchetti. Also available in coils. Aussi disponible en bobine. Auch in Spule verfügbar. También disponible en bobina.

mm	mm	mt
6	16	20
8	17	20
10	19	20



Sottostrato
Inner layer
Couche Intérieure
Schlaucheinlage
Capa interior



Inserti
Reinforcement
Renforcement
Einlagen
Refuerzos



Copertura
Outer Cover
Couche extérieure
Außenschicht
Capa exterior



-35°C / +80°C
+31°F / +176°F



• **EXTRA FLEXIBLE**



IMPIEGO / USE / EMPLOI / EINSATZ / EMPLEO

Per mandata di carburanti, gasolio, benzine senza piombo, eco diesel e lubrificanti in generale. Utilizzato sui motori a combustione interna delle autovetture, degli autoveicoli industriali, dei trattori e dei motori marini.

For the delivery of fuel such as gasoline, unleaded gasoline, eco diesel and lubricants in general. Used for internal combustion engines of cars, industrial vehicles, tractors and marine engines.

Pour le refoulement des carburants tels que essence, essence sans plomb, diesel éco et lubrifiants en général. Utilisé pour moteurs de combustion interne, voitures, véhicules industriels et moteurs marins.

Kraftstoffschlauch für Kraftfahrzeuge und Fettpumpen. Geeignet für Industriefahrzeuge und Schiffsmotoren.

Para la entrega de carburantes como gasolina, gasolina sin plomo, diesel eco y lubricantes en general. Utilizado para motores de combustión interna, coches, vehículos industriales y motores marinos.

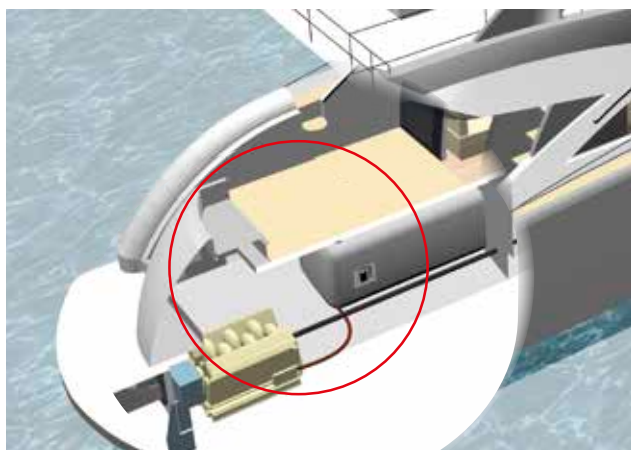

**STRUTTURA / STRUCTURE / STRUCTURE
STRUKTUR / ESTRUCTURA**

SOTTOSTRATO

INNER LAYER
COUCHE INTÉRIEURE
SCHLAUCHEINLAGE
CAPA INTERIOR

Liscio in gomma nera (NBR) resistente agli oli minerali, ai carburanti con contenuto aromatico non superiore al 50% e alle benzine senza piombo con contenuto di MTBE non superiore al 5%.

Black rubber (NBR), smooth, resistant to fuel with maximum 50% aromatic content and to unleaded gasoline with MTBE content up to 5%.

Caoutchouc noir (NBR), lisse, résistant aux carburants au contenu aromatique non supérieur de 50% et essence sans plomb au contenu en MTBE non supérieur de 5%.

Schwarzer NBR Gummi, resistent gegen Öle und Kraftstoffe für Mineralölprodukte mit max. 50% Aromatengehalt. Resistent gegen bleifreies Benzin, MTBE-Gehalt von nicht mehr als 5%.

Caucho negro (NBR), liso, resistente a los carburantes con contenido aromático no superior de 50% y a la gasolina sin plomo con MTBE no superior de 5%.

INSERTI

REINFORCEMENT
RENFORCEMENT
EINLAGEN
REFUERZOS

Tessili, sintetici.

High tensile synthetic textile.

Insertion textile haute tenacite.

Hochzugfeste synthetische Textileinlage.

Inserciones textiles con alta resistencia.

COPERTURA

OUTER COVER
COUCHE EXTERIEURE
AUSSENSCHICHT
CAPA EXTERIOR

Gomma nera (CR/NBR) resistente ai lubrificanti, ai carburanti all'abrasione ed agli agenti atmosferici. **Superficie:** liscia.

Black special synthetic rubber (CN/NBR), antiabrasive, fuel, oil and weathering condition resistant.

Outer layer: smooth.

Caoutchouc synthétique special, résistant a+ l'abrasion, aux huiles et aux agents atmosphériques. **Couche extérieure:** lisse.

Abriebfest, öl- und witterungsbeständig. Spezieller synthetischer Gummi. **Oberfläche:** glatt.

Caucho sintético especial negro (CN/NBR), antiabrasivo, resisistente a los carburantes, lubricantes y a los agentes atmosféricos. **Capa exterior:** lisa.

mm	mm	bar	bar	bar	g/m	mm	mt
4	9	10	30	-	60	40	100
5	10	10	30	-	80	50	100
6	13	10	30	-	140	60	100
7	13	10	30	-	130	70	100
7,5	14,5	10	30	-	168	75	100
8	14,5	10	30	-	160	80	100
10	16	10	30	-	170	100	100

IMBALLO: polietilene trasparente **PACKAGING:** transparent polyethylene

EMBALLAGE: polyéthylène transparent **VERPACKUNG:** transparentes Polyethylen

EMBALAJE: polietileno transparente



Disponibili anche in rocchetti. Also available in coils. Aussi disponible en bobine. Auch in Spule verfügbar. También disponible en bobina.

mm	mm	mt
4	9	20
5	10	20
6	13	15
7	13	10
7,5	14,5	10
8	14,5	10
10	16	10

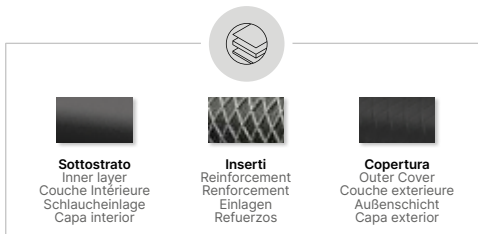



• **LOW COST**



IMPIEGO / USE / EMPLOI / EINSATZ / EMPLEO

Idoneo per la mandata di carburanti anche benzina verde.

Suitable for the delivery of fuel including unleaded gasoline.

Convenable pour le refoulement de carburants et de l'essence sans plomb incluse.

Geeignet für die Lieferung von Brennstoffen und bleifreiem Benzin.

Adecuado para la entrega de carburantes y gasolina sin plomo incluida .

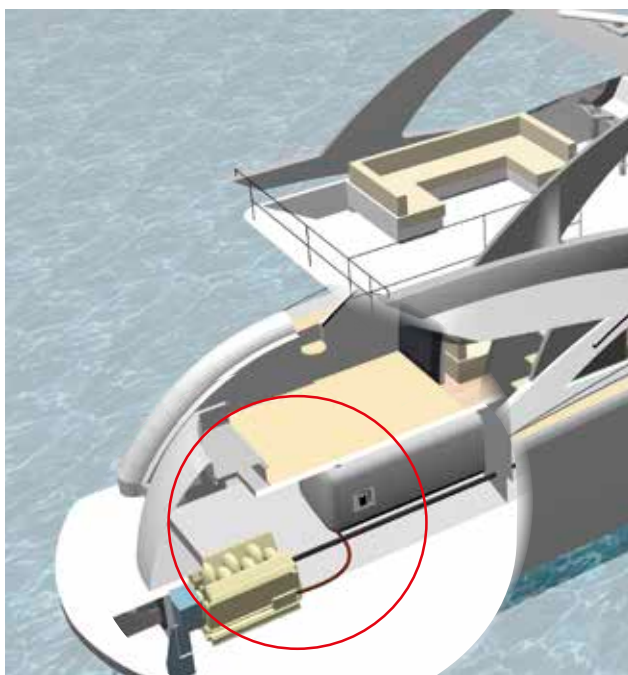

**STRUTTURA / STRUCTURE / STRUCTURE
STRUKTUR / ESTRUCTURA**

MATERIALE

MATERIAL
MATERIAU
MATERIAL
MATERIAL

PVC verde trasparente.
Transparent green PVC.
PVC vert transparent.
Grünes transparentes PVC.
PVC verde transparente.

IMBALLO: polietilene trasparente **PACKAGING:** transparent polyethylene
EMBALLAGE: polyéthylène transparent **VERPACKUNG:** transparentes Polyethylen
EMBALAJE: polietileno transparente

mm	mm	bar	bar	g/m	mt
4	7	5	15	31	25
5	9	5	15	53	25
7	12	5	15	91	25
8	13	5	15	100	25
9	14	5	15	111	25
10	15	4	12	120	25



Sottostrato
Inner layer
Couche Intérieure
Schlaucheinlage
Capa interior



-5°C / +60°C
+23°F / +140°F



- **VERY LIGHT**
- **LOW COST**



IMPIEGO / USE / EMPLOI / EINSATZ / EMPLEO

Idoneo per mandata di carburanti, diesel eco e benzina verde.

Suitable for the delivery of fuel, including eco diesel and unleaded gasoline.

Convenable pour le refoulement des carburants, diesel eco et essence sans plomb inclus.

Geeignet für die Lieferung von Kraftstoffen, Öko-Diesel und bleifreiem Benzin.

Adecuado para la entrega de carburantes, eco diesel y gasolina sin plomo incluidos.

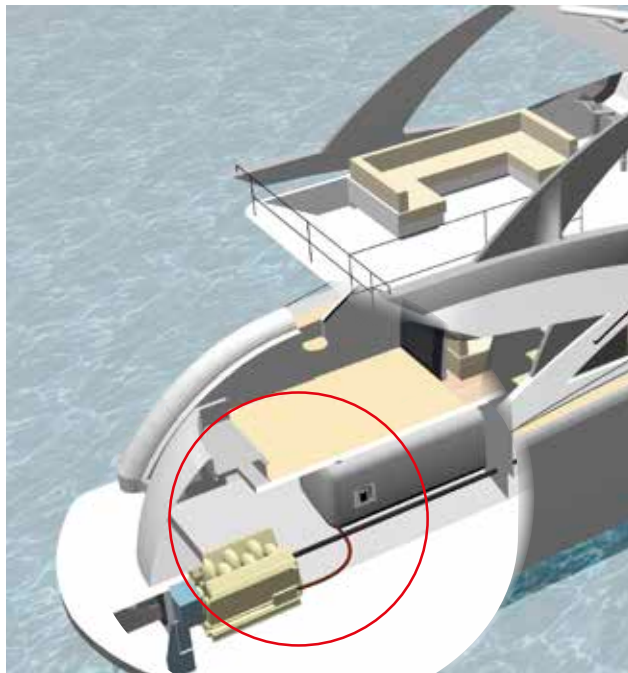

STRUTTURA / STRUCTURE / STRUCTURE STRUKTUR / ESTRUCTURA

SOTTOSTRATO

INNER LAYER
COUCHE INTÉRIEURE
SCHLAUCHEINLAGE
CAPA INTERIOR **A**

Liscio in PVC trasparente, antiolio anche per eco diesel e benzina verde.

PVC smooth, transparent, oil resistant, including eco diesel and unleaded gasoline.

En PVC lisse, transparent, résistant aux carburants, diesel eco et essence sans plombs inclus.

Glatt aus transparentem PVC, ölbeständig, ebenso gegen Öko-Diesel und bleifreies Benzin.

En PVC liso, transparente, resistente a los carburantes, eco diesel y gasolina sin plomo incluidos.

INSERTI

REINFORCEMENT
REINFORCEMENT
EINLAGEN
REFUERZOS **B**

Tessili sintetici ad alta resistenza.

High tenacity synthetic textile yarns.

Gâines synthétiques textiles de haute ténacité.

Hochfeste synthetische Textilgarne.

Hilos sintéticos textiles de alta tenacidad.

COPERTURA

OUTER COVER
COUCHE EXTERIEURE
AUSSENSCHICHT
CAPA EXTERIOR **C**

In PVC nera opaca, resistente agli olii, olii eco e agenti atmosferici. **Superficie:** liscia estrusa.







Black PVC opaque, smooth, oil, green fuel and weathering resistant. **Outer layer:** smooth extruded.

En PVC noir opaque, lisse, résistant aux carburants, carburants éco et aux agents atmosphériques. **Couche extérieure:** lisse extrudée.

Aus mattschwarzem PVC, beständig gegen Öle, Öko-öle und Witterungseinflüsse. **Oberfläche:** extrudiert glatt.

En PVC negro opaco, resistente a los carburantes, carburantes eco y agentes atmosféricos. **Capa exterior:** lisa extruido.

IMBALLO: polietilene trasparente **PACKAGING:** transparent polyethylene
EMBALLAGE: polyéthylène transparent **VERPACKUNG:** transparentes Polyethylen
EMBALAJE: polietileno transparente

 mm	 mm	 bar	 bar	 g/m	 mt
5	10.5	10	30	80	25
6	11	10	30	80	25
8	14	10	30	110	25
10	16	10	30	140	25



Sottostrato
Inner Layer
Couche Intérieure
Schlaucheinlage
Capa interior



Inserti
Reinforcement
Renforcement
Einlagen
Refuerzos





Copertura
Outer Cover
Couche extérieure
Außenschicht
Capa exterior



-4°C / +60°C
+23°F / +140°F



- FLEXIBLE
- LOW BENDING RADIUS
- HOMOLOGATED  



IMPIEGO / USE / EMPLOI / EINSATZ / EMPLEO

Idoneo per mandata e aspirazione di carburanti nelle imbarcazioni e navi da diporto. Particolarmente utilizzato per usi gravosi. Si caratterizza per la sua leggerezza e flessibilità. Omologato R.I.N.A secondo Direttiva Europea 2013/53/UE - ISO 7840: 2021 - A1 e LLOYD'S.

Ideal for fuel suction & delivery for boats and yachts. Heavy duty, very flexible and light-weight hose. R.I.N.A approved, according to Directive 2013/53/EU - ISO 7840: 2021 - A1 and LLOYD'S

Idéal pour l'aspiration et refoulement des carburants pour les navires et bateaux de plaisance. Tuyau pour applications lourdes, très flexible et de poids léger. Homologué R.I.N.A. selon Directive 2013/53/UE - ISO 7840: 2021 - A1 et LLOYD'S.

Geeignet für die Zufuhr und das Absaugen von Kraftstoffen in Booten und Schiffen. Vor allem geeignet bei hohen Belastungen. Er zeichnet sich durch seine Leichtigkeit und Flexibilität aus. Genehmigt R.I.N.A. Ander. Richtl 2013/53/EU - ISO 7840: 2021 - A1 und LLOYD'S.

idónea para la aspiración y la entrega de carburantes en barcos y embarcaciones de recreo. Manguera para aplicaciones pesadas, muy flexible y ligera de peso. Homologada R.I.N.A. segundo Directiva 2013/53/UE - ISO 7840: 2021 - A1 y LLOYD'S.

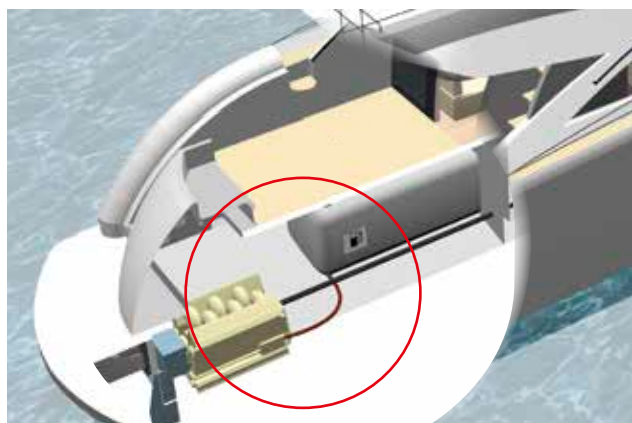

STRUTTURA / STRUCTURE / STRUCTURE STRUKTUR / ESTRUCTURA

SOTTOSTRATO
INNER LAYER
COUCHE INTÉRIEURE
SCHLAUCHEINLAGE
CAPA INTERIOR **A**

Liscio in gomma nera (NBR) resistente ai carburanti con contenuto aromatico non superiore al 50%.
NBR black oil/fuel rubber, smooth, resistant to maximum 50% aromatic contents.
Lisse en caoutchouc noir (NBR) résistante aux carburants avec contenu aromatique non supérieure à 50%.

Glatt aus schwarzem Kraftstoffbeständigem Gummi (NBR) mit einem Aromagehalt, der 50% nicht übersteigt.

Lisa de goma negra (NBR) resistente a los carburantes con contenido aromático no superior a 50%.

INSERTI
REINFORCEMENT
RENFORCEMENT
EINLAGEN
REFUERZOS **B**

Tessili, sintetici ad alta tenacità e spirale metallica incorporata.

Synthetic textile high tenacity yarns and embedded steel spiral.

Gaines textiles synthétiques de haute ténacité et spirale en acier incorporée.

Synthetisches Gewebe mit hoher Reißfestigkeit.

Hilos textiles, sintéticos de alta tenacidad y espiral metálica incorporada.

COPERTURA
OUTER COVER
COUCHE EXTERIEURE
AUSSENSCHICHT
CAPA EXTERIOR **C**









Mescola in gomma sintetica resistente alla fiamma, ai lubrificanti, ai carburanti all'abrasione, all'acqua di mare ed agli agenti atmosferici. **Superficie:** liscia.

Synthetic rubber compound, flame, oil, lubricant, abrasion, sea water and weathering resistant. **Outer layer:** smooth.

Composé en caoutchouc synthétique, anti-flammes, antiabrasif, résistant aux carburants, aux lubrifiants, à l'eau marine et aux agents atmosphériques. **Couche extérieure:** lisse.

Verbindung aus synthetischem Gummi; beständig gegen Flammen, Schmiermitteln, Treibstoffen, Abrieb, Meerwasser und Witterungseinwirkungen. **Oberfläche:** glatt.

Compuesto en caucho sintético, antillamas, antiabrasivo, resistente a los carburantes, lubricantes, a l'agua marina y a los agentes atmosféricos. **Capa exterior:** lisa.

							
mm	mm	bar	bar	bar	g/m	mm	mt
19	31	2,5	10	-0,35	758	90	20
20	32	2,5	10	-0,35	787	100	20
22	34	2,5	10	-0,35	837	110	20
25	37	2,5	10	-0,35	918	125	20
30	42	2,5	10	-0,8	1.087	150	20
32	44	2,5	10	-0,8	1.148	160	20
35	47	2,5	10	-0,8	1.335	175	20
38	50	2,5	10	-0,8	1.433	190	20
40	52	2,5	10	-0,8	1.498	200	20
45	59	2,5	10	-0,8	1.954	223	20
51	63	2,5	10	-0,8	1.942	254	20
60	72	2,5	10	-0,8	2.226	300	20
63	76	2,5	10	-0,8	2.406	318	20

IMBALLO: polietilene blu PACKAGING: Blue polyethylene EMBALLAGE: polyéthylène bleu
VERPACKUNG: blaues Polyethylen EMBALAJE: polietileno azul



Sottostrato
Inner layer
Couche Intérieure
Schlaucheinlage
Capa interior



Inserti
Reinforcement
Renforcement
Einlagen
Refuerzos



Copertura
Outer Cover
Couche extérieure
Außenschicht
Capa exterior





-20°C / +100°C
+4°F / +212°F

MARCATURA / MARKING / MARQUAGE / BESCHRIFTUNG / MARCATURA

EUROCORD®

CARBOMARINE I.D. ... EN ISO 7840: 2021 A1 e E10/B10 COMPATIBILE R.I.N.A APPROVED - CE
- YEAR -  - FUEL HOSE - SAE J 1527:2011 USCG A1 - LLOYD'S APPROVED



- EXTRA FLEXIBLE TYPE
- EVEN LOWER BENDING RADIUS
- HOMOLOGATED  
- CORRUGATED OUTER SURFACE



IMPIEGO / USE / EMPLOI / EINSATZ / EMPLEO

Idoneo per mandata e aspirazione di carburanti nelle imbarcazioni e navi da diporto. Particolarmente utilizzato per usi gravosi. Si caratterizza per la sua leggerezza e flessibilità. Omologato R.I.N.A secondo Direttiva Europea 2013/53/UE - ISO 7840: 2021 - A1 e LLOYD'S.

Suitable for fuel suction & delivery on boats and in the light marine industry. Suitable for heavy duties. Flexibility and lightness are a characteristic of this hose. R.I.N.A approved, according to Directive 2013/53/UE - ISO 7840: 2021 - A1 and LLOYD'S.

Idéal pour l'évacuation des carburants sur les navires et bateaux de plaisance. Il est aussi utilisé comme raccord flexible pour l'évacuation de l'eau de refroidissement des moteurs. Homologué R.I.N.A. selon Directive 2013/53/UE - ISO 7840: 2021 - A1 et LLOYD'S.

Geeignet für Zufuhr und Absaugen von Kraftstoffen in Booten und Schiffen für die Sportschifffahrt. Insbesondere für hohe Belastung verwendet. Er zeichnet sich durch seine Leichtigkeit und Flexibilität aus. Genehmigt R.I.N.A, Ander. Richtl 2013/53/UE - ISO 7840: 2021 - A1 und LLOYD'S.

Idóneo para la aspiración y entrega de carburantes en barcos y embarcaciones de recreo. También se utiliza como una conexión flexible para la descarga de agua de refrigeración de los motores. Homologada R.I.N.A. segundo Directiva 2013/53/UE - ISO 7840: 2021 - A1 y LLOYD'S.

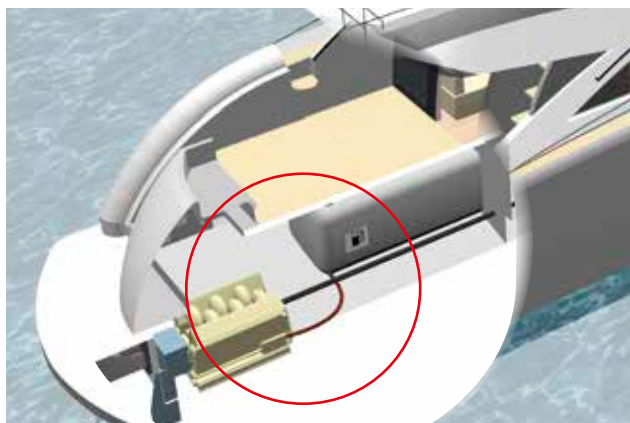

**STRUTTURA / STRUCTURE / STRUCTURE
STRUKTUR / ESTRUCTURA**

SOTTOSTRATO
INNER LAYER
COUCHE INTÉRIEURE
SCHLAUCHEINLAGE
CAPA INTERIOR **A**









Liscio in gomma nera (NBR) resistente ai carburanti con contenuto aromatico non superiore al 50%.
NBR black oil/fuel rubber, smooth, resistant to maximum 50% aromatic contents.
Lisse en caoutchouc noir (NBR) résistante aux carburants avec contenu aromatique non supérieur à 50%.
Glatt aus schwarzem kraftstoffbeständigem Gummi (NBR) mit einem Aromagehalt, der 50% nicht übersteigt.
Lisa de goma negra (NBR) resistente a los carburantes con contenido aromático no superior a 50%.

INSERTI
REINFORCEMENT
RENFORCEMENT
EINLAGEN
REFUERZOS **B**



Tessili, sintetici ad alta tenacità e spirale metallica incorporata.
Synthetic textile high tenacity yarns and embedded steel spiral.
Gaines textiles synthétiques de haute ténacité et spirale en acier incorporée.
Synthetisches Gewebe mit hoher Reißfestigkeit.
Hilos textiles, sintéticos de alta tenacidad y espiral metálica incorporada.

COPERTURA
OUTER COVER
COUCHE EXTERIEURE
AUSSENSCHICHT
CAPA EXTERIOR **C**

Mescola in gomma sintetica resistente alla fiamma, ai lubrificanti, ai carburanti all'abrasione, all'acqua di mare ed agli agenti atmosferici. Superficie: liscia.
Synthetic rubber compound, flame, oil, lubricant, abrasion, sea water and weathering resistant. Outer layer: smooth.
Composé en caoutchouc synthétique, anti-flammes, antiabrasif, résistant aux carburants, aux lubrifiants, à l'eau marine et aux agents atmosphériques. Couche extérieure: lisse.
Verbindung aus synthetischem Gummi; beständig gegen Flammen, Schmiermitteln, Treibstoffen, Abrieb, Meerwasser und Witterungseinwirkungen. Oberfläche: glatt.
Compuesto en caucho sintético, antillamas, antiabrasivo, resistente a los carburantes, lubricantes, a l'agua marina y a los agentes atmosféricos. Capa exterior: lisa.

							
mm	mm	bar	bar	bar	g/m	mm	mt
19	31	5	15	-0.8	585	49	20
20	32	5	15	-0.8	616	52	20
22	31	5	15	-0.8	677	57	20
25	37	5	15	-0.8	770	65	20
30	40	5	15	-0.8	910	89	20
32	44	5	15	-0.8	970	95	20
35	46	5	15	-0.8	1096	105	20
38	50	5	15	-0.8	1190	115	20
40	52	5	15	-0.8	1252	129	20
45	59	5	15	-0.8	1409	145	20
51	61	5	15	-0.8	1540	165	20
60	72	5	15	-0.8	1811	194	20
63	76	5	15	-0.8	1902	203	20

IMBALLO: polietilene blu **PACKAGING:** Blue polyethylene **EMBALLAGE:** polyéthylène bleu **VERPACKUNG:** blaues Polyethylen **EMBALAJE:** polietileno azul

Sottostrato
Inner layer
Couche Intérieure
Schlaucheinlage
Capa interior

Inserti
Reinforcement
Renforcement
Einlagen
Refuerzos



Copertura
Outer Cover
Couche extérieure
Außenschicht
Capa exterior



-20°C / +100°C
+4°F / +212°F



• **LONG LIFE PERFORMANCE STRUCTURE**

• **HOMOLOGATED**



IMPIEGO / USE / EMPLOI / EINSATZ / EMPLEO

Idoneo per adduzione di carburanti diesel e benzine ecologiche nelle imbarcazioni e navi da diporto. Particolarmente utilizzato per usi gravosi. Si caratterizza per la sua leggerezza e flessibilità. **Omologato R.I.N.A secondo Direttiva Europea 2013/53/UE - ISO 7840: 2021 - A1 e LLOYD'S.**

Suitable for diesel and fuel transfer for marine craft. Long Life structure. **R.I.N.A approved, according to Directive 2013/53/UE - ISO 7840: 2021 - A1 and LLOYD'S.**

Idéal pour le transfert des carburants tels que diesel et essences écologiques aux bateaux et les navires de plaisance. Particulièrement utilisé pour des emplois lourds. Il se caractérise par sa légèreté et flexibilité. **Homologué R.I.N.A. selon Directive 2013/53/UE - ISO 7840: 2021 - A1 et LLOYD'S**

Geeignet für die Adduktion von ökologischen Diesel- und Benzinkraftstoffen in Booten und Schiffen für die Sportschiffahrt. Extrem flexibler und leichter Schlauch mit optimalem Biegeungsradius. **Genehmigt R.I.N.A, Ander. Richtl 2013/53/UE - ISO 7840: 2021 - A1 und LLOYD'S.**

Idóneo para la conducción de carburantes diésel y gasolinas ecológicas en los barcos y embarcaciones de recreo. Especialmente utilizado para usos intensivos. Se caracteriza por su ligereza y flexibilidad. **Homologada R.I.N.A. segundo Directiva 2013/53/UE - ISO 7840: 2021 - A1 y LLOYD'S.**

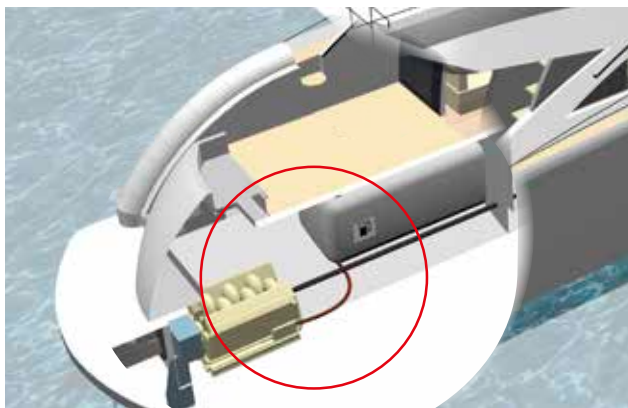

**STRUTTURA / STRUCTURE / STRUCTURE
STRUKTUR / ESTRUCTURA**

SOTTOSTRATO
INNER LAYER
COUCHE INTÉRIEURE
SCHLAUCHEINLAGE
CAPA INTERIOR

Liscio in gomma nera (NBR) resistente ai carburanti con contenuto aromatico non superiore al 50%.
Black (NBR) rubber, smooth, oil resistant to fuel with maximum 50% aromatic content.
Lisse en caoutchouc noir (NBR) résistante aux carburants au contenu aromatique non supérieur de 50%.

Glatt aus schwarzem kraftstoffbeständigem Gummi (NBR) mit einem Aromagehalt, der 50% nicht übersteigt.

Lisa en caucho negro (NBR) resistente a los carburantes con contenido aromático no superior de 50%.

INSERTI
REINFORCEMENT
REINFORCEMENT
EINLAGEN
REFUERZOS

Tessili, sintetici ad alta tenacità.
Synthetic textile high tenacity yarns.
Gaines textiles synthétiques de haute ténacité.
Synthetisches Gewebe mit hoher Reißfestigkeit.
Hilos textiles, sintéticos de alta tenacidad.

COPERTURA
OUTER COVER
COUCHE EXTERIEURE
AUßENSCHICHT
CAPA EXTERIOR

Mescola in gomma sintetica resistente alla fiamma, ai lubrificanti, ai carburanti all'abrasione, all'acqua di mare ed agli agenti atmosferici. **Superficie: liscia.**
Synthetic rubber compound resistant to flame, lubricant, oil, sea water and weathering conditions. **Outer layer: smooth.**
Mélange en caoutchouc synthétique, anti-flammes, résistant aux lubrifiants, aux carburants, à l'abrasion, à l'eau de mer et aux agents atmosphériques. **Couche extérieure: lisse.**
Verbindung aus synthetischem Gummi; beständig gegen Flammen, Schmiermitteln, Treibstoffen, Abrieb, Meerwasser und Witterungseinwirkungen. **Oberfläche: glatt.**
Mezcla en caucho sintético, anti-llamas, resistente a los lubricantes, a los carburantes, a la abrasión, al agua de mar y a los agentes atmosféricos. **Capa exterior: lisa.**

mm	mm	bar	bar	bar	g/m	mm	mt
19	31	2,5	10	-	705	190	20
20	32	2,5	10	-	733	200	20
22	34	2,5	10	-	789	220	20
25	37	2,5	10	-	853	254	20
30	42	2,5	10	-	1.012	300	20
32	44	2,5	10	-	1.068	320	20
35	47	2,5	10	-	1.152	350	20
38	50	2,5	10	-	1.235	380	20
40	52	2,5	10	-	1.340	400	20
45	58	2,5	10	-	1.723	445	20
50	63	2,5	10	-	1.577	508	20
60	72	2,5	10	-	1.831	600	20
63	76	2,5	10	-	1.989	630	20

IMBALLO: polietilene blu **PACKAGING:** Blue polyethylene

VERPACKUNG: blaues Polyethylen **EMBALAJE:** polietileno azul **EMBALLAGE:** polyéthylène bleu



Sottostrato
Inner layer
Couche Intérieure
Schlaucheinlage
Capa interior



Inserti
Reinforcement
Reinforcement
Einlagen
Refuerzos



Copertura
Outer Cover
Couche extérieure
Außenschicht
Capa exterior

-20°C / +100°C
+4°F / +212°F

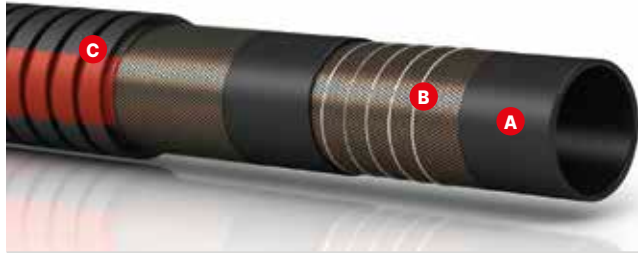

- **EXTRA FLEXIBLE**
- **VERY LOW BENDING RADIUS**



IMPIEGO / USE / EMPLOI / EINSATZ / EMPLEO

Per aspirazione e mandata oli, gasolio, benzine e prodotti petroliferi. Particolarmente indicato negli impieghi in cui vengano richiesti ridotti raggi di curvatura.

Ideal for fuel and oil derivatives. Appropriate for low bending radius use.

Idéal pour le refolement des carburants et des dérivés du pétrole. Appropriate pour usages au rayon de courbure très réduit.

Geeignet für die Lieferung und Absaugung von Kraftstoffen und Öl. Geeignet für einen geringen Biegungsradius.

Idóneo para la aspiración y entrega de carburantes y derivados petrolíferos. Adecuado para usos con radio de curvatura muy reducido.

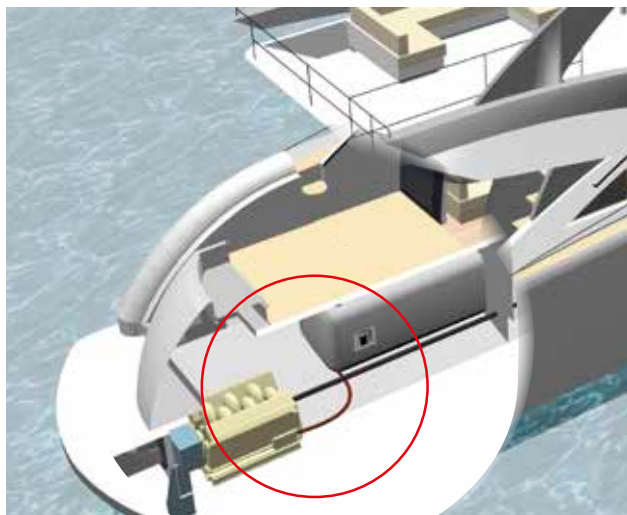

STRUTTURA / STRUCTURE / STRUCTURE
STRUKTUR / ESTRUCTURA

SOTTOSTRATO

INNER LAYER
COUCHE INTÉRIEURE
SCHLAUCHEINLAGE
CAPA INTERIOR



Gomma speciale sintética NBR, antiabrasiva, resistente agli oli, agenti atmosferici e all'acqua di mare. Superficie grecata ad impressione tela.

NBR black oil/fuel rubber, smooth, resistant to maximum 50% aromatic contents.

Lisse en caoutchouc noir (NBR) résistante aux carburants avec contenu aromatique non supérieur à 50%.

Glatt aus schwarzem kraftstoffbeständigem Gummi (NBR) mit einem Aromagehalt, der 50% nicht übersteigt.

Lisa de goma negra (NBR) resistente a los carburantes con contenido aromático no superior a 50%.

INSERTI

REINFORCEMENT
RENFORCEMENT
EINLAGEN
REFUERZOS



Tessili, sintetici ad alta tenacità e spirale metallica incorporata.

Synthetic textile high tenacity yarns and embedded steel spiral.

Gânes textiles synthétiques de haute ténacité et spirale en acier incorporée.

Synthetisches Gewebe mit hoher Reißfestigkeit.

Hilos textiles, sintéticos de alta tenacidad y espiral metálica incorporada.

COPERTURA

OUTER COVER
COUCHE EXTERIEURE
AUSSENSCHICHT
CAPA EXTERIOR



Gomma EPDM resistente agli oli, agenti atmosferici, ozono e all'acqua di mare. Superficie: grecata ad impressione tela.

Special synthetic EPDM rubber, antiabrasive, oil and sea water resistant. Outer layer: corrugated cloth impression.

Caoutchouc en EPDM spécial synthétique, antiabrasif, résistant aux carburants, aux agents atmosphériques et à l'eau de mer. Couche extérieure: ondulée entoïlée.

Spezieller EPDM-Synthesekautschuk, abriebfest, beständig gegen Öle, Witterungseinflüsse und Meerwasser. Oberfläche: Gewellt mit Leinwandeindruck.

Caucho en EPDM especial sintético, antiabrasivo, resistente a los carburantes, agentes atmosféricos y a la agua marina. Capa exterior: corrugada con impresión de tela.

mm	mm	bar	bar	bar	g/m	mm	mt
15	25	10	30	0,8	380	45	40
16	26	10	30	0,8	410	48	40
18	28	10	30	0,8	450	54	40
19	29	10	30	0,8	570	75	40
20	30	10	30	0,8	483	60	40
22	32	10	30	0,8	520	66	40
25	35	10	30	0,8	570	75	40
28	38	10	30	0,8	630	84	40
30	40	10	30	0,8	670	90	40
32	43	10	30	0,8	790	100	40
35	45	10	30	0,8	820	105	40
38	48	10	30	0,8	840	114	40
40	51	10	30	0,8	870	120	40
42	53	10	30	0,8	960	126	40
45	56	10	30	0,8	1000	135	40
48	59	10	30	0,8	1080	144	40
51	63	10	30	0,8	1410	153	40
55	67	10	30	0,8	1510	165	40
60	72	10	30	0,8	1500	180	40
70	82	10	30	0,8	2080	210	40
76	88	10	30	0,8	2170	228	40
80	92	10	30	0,8	2300	475	20-40
90	104	10	30	0,8	2980	522	20
102	116	10	30	0,8	4133	610	20-40
120	138	10	30	0,8	7400	720	20

IMBALLO: polietilene nero **PACKAGING:** Black polyethylene
EMBALLAGE: polyéthylène noir **VERPACKUNG:** Schwarzes Polyethylen
EMBALAJE: polietileno negro



Sottostrato
Inner layer
Couche intérieure
Schlaucheinlage
Capa interior



Inserti
Reinforcement
Renforcement
Einlagen
Refuerzos



Copertura
Outer Cover
Couche extérieure
Außenschicht
Capa exterior



-35°C / +70°C
-31°F / +158°F



- **SUPER FLEXIBLE**
- **VERY LOW BENDING RADIUS**
- **HOMOLOGATED**



IMPIEGO / USE / EMPLOI / EINSATZ / EMPLEO

Idoneo per scarico di gas combusto e di raffreddamento degli scambiatori di calore sulle navi ed imbarcazioni da diporto. Grazie alla sua particolare struttura risulta essere molto flessibile e con ottimi raggi di curvatura. Tubo omologato R.I.N.A secondo ISO 13363:2006 Type 1 class A&B, Type 2 class A&B e LLOYD'S SAE J 2006:03 R1 e R2.

Ideal for exhaust gas discharge and for the cooling of heating systems in boats and yachts. Very flexible thanks to a particular structure with extremely low bending radius. R.I.N.A approved, according to Directive ISO 13363:2006 Type 1 class A&B, Type 2 class A&B and LLOYD'S SAE J 2006:03 R1 and R2.

Idéal pour l'évacuation des gaz d'échappement et pour le refroidissement des échangeurs de chaleur aux navires et bateaux de plaisance. Très souple grâce à une structure particulière aux rayons de courbure extrêmement bas. Homologué R.I.N.A selon Directive ISO 13363:2006 Type 1 class A&B, type 2 class A&B and LLOYD'S SAE J 2006:03 R1 et R2.

Geeignet für das Ableiten von Ab- und Kühlgasen der Wärmeübertrager auf Booten und Schiffen für die Sportschiffahrt. Dank seiner besonderen Struktur erweist er sich als sehr flexibel und mit einem optimalen Biegungsradius. Genehmigt R.I.N.A, ISO 13363:2006 Type 1 class A&B, type 2 class A&B und LLOYD'S SAE J 2006:03 R1 und R2.

Idóneo para la descarga de gases de escape y para la refrigeración de intercambiadores de calor en barcos y embarcaciones de recreo. Muy flexible gracias a una estructura particular con radios de curvatura extramadamente bajos. Homologada R.I.N.A. segundo Directiva ISO 13363:2006 Type 1 class A&B, type 2 class A&B y LLOYD'S SAE J 2006:03 R1 y R2.

mm	mm*	bar	bar	bar	g/m	mm	mt
19	29-31	3	9	0,3	370	19	20
20	29-31	3	9	0,3	386	19	20
25	32-35	3	9	0,3	473	24	20
30	40-43	3	9	0,3	573	28	20
32	40-43	3	9	0,3	633	30	10-20
35	44-47	3	9	0,3	657	33	20
38	48-51	3	9	0,3	707	36	10-20
40	48-51	3	9	0,3	741	38	10-20
45	52-55	3	9	0,3	884	43	10-20
51	60-63	3	9	0,3	999	49	10-20
55	64-67	3	9	0,3	1096	53	20
60	68-73	3	9	0,3	1189	57	10-20
63	74-79	3	9	0,3	1253	60	20
65	74-79	3	9	0,3	1281	62	20
70	80-85	3	9	0,3	1374	68	10-20
76	86-91	3	9	0,3	1719	72	10-20
80	86-91	3	9	0,3	1828	76	10-20
90	98-103	3	9	0,3	2046	86	10-20
100	104-112	3	9	0,3	2502	95	10-20
102	113-121	3	9	0,3	2540	97	10-20
110	122-130	3	9	0,3	2706	200	10-20
115	122-130	3	9	0,3	2800	209	10-20
120	131-139	3	9	0,3	2942	218	10-20
127	131-139	3	9	0,3	3107	231	10-20
130	140-148	3	9	0,3	3178	236	10-20
140	149-161	3	9	0,3	3860	254	10-20
152	162-174	3	9	0,3	4856	276	10-20
168	175-187	3	9	0,3	5450	463	20
180	188-200	3	9	0,3	5703	650	20
203	214-226	3	9	0,3	6859	751	10

* Misura collare suggerita / Collar size suggested



**STRUTTURA / STRUCTURE / STRUCTURE
STRUKTUR / ESTRUCTURA**

SOTTOSTRATO
INNER LAYER
COUCHE INTÉRIEURE
SCHLAUCHEINLAGE
CAPA INTERIOR

Liscio in gomma nera resistente ai gas combusto e all'acqua di mare.

Smooth black rubber, exhaust gas and sea water resistant.

Lisse en caoutchouc noir, résistant aux gaz d'échappement et à l'eau de mer.

Glatt, aus schwarzem Gummi und beständig gegen Abgase und Meerwasser.

En caucho liso, negro, resistente a los gases de escape y al agua del mar.

INSERTI
REINFORCEMENT
RENFORCEMENT
EINLAGEN
REFUERZOS

2 Spirali metalliche incorporate ed inserti tessili, sintetici ad alta tenacità.

2 High tenacity textile synthetic yarns, embedded double steel spiral.

2 Gâines textile synthétique de haute ténacité, double spirale en acier incorporée.

2 eingebaute Metallspiralen und inerte synthetische Gewebe mit hoher Reißfestigkeit.

2 Hilos textiles, sintéticos de alta tenacidad, espiral doble en acero incorporada.

COPERTURA
OUTER COVER
COUCHE EXTERIEURE
AUSSENSCHICHT
CAPA EXTERIOR

Gomma nera resistente all'abrasione, all'acqua di mare, agli agenti atmosferici. Superficie: corrugata ad impressione tela.

Black rubber, antiabrasive, heat, weathering and sea water resistant. Outer layer: corrugated cloth impression.

Caoutchouc noir, antiabrasif, résistant à la chaleur, aux agents atmosphériques et à l'eau de mer. Couche extérieure: ondulée entoilée.

Strapazierfähiger schwarzer Gummi resistent gegen Abrieb, Meerwasser und Witterung. Oberfläche: gewellt mit Leinwandabdruck.

Caucho negro, antiabrasivo, resistente al calor, a los agentes atmosféricos y al agua de mar. Capa exterior: corrugada con impresión de tela.

IMBALLO: polietilene blu PACKAGING: Blue polyethylene EMBALLAGE: polyéthylène bleu VERPACKUNG: blaues Polyethylen EMBALAJE: polietileno azul



Sottostrato
Inner layer
Couche Intérieure
Schlaucheinlage
Capa interior



Inserti
Reinforcement
Renforcement
Einlagen
Refuerzos



Copertura
Outer Cover
Couche extérieure
Außenschicht
Capa exterior



-30°C / +100°C
con picchi fino a
with peaks up to +115°C
+22°F / +212°F
con picchi fino a
with peaks up to +239°F



- RESISTANT TO VERY HIGH TEMPERATURE
- VERY LOW BENDING RADIUS



IMPIEGO / USE / EMPLOI / EINSATZ / EMPLEO

Idoneo per scarico di gas combustibili e di raffreddamento degli scambiatori di calore sotto temperature alte sulle navi ed imbarcazioni di diporto. **Conforme alla normativa SAE J2006 R2 CLASS B MARINE EXHAUST HOSE.**

Idéal pour l'évacuation des gaz d'échappement et pour le refroidissement des échangeurs de chaleur sous hautes températures aux navires et bateaux de plaisance. **Conform to norm SAE J2006 R2 CLASS B MARINE EXHAUST HOSE.**

Flexibler Schlauch, der zum Durchfließen des Kühlwassers und der Abgase der Verbrennungsmotoren bei hohen Temperaturen von Booten und Schiffen für die Sportschiffahrt geeignet ist. **Stimmt mit der Verordnung SAE J2006 R2 CLASS B MARINE EXHAUST HOSE überein.**

Idóneo para la descarga de gases de escape y para la refrigeración de intercambiadores de calor bajo altas temperaturas en barcos y embarcaciones de recreo. **Conforme a la norma SAE J2006 R2 CLASS B MARINE EXHAUST HOSE.**

mm	mm	bar	bar	bar	g/m	mm	mt
19	-	-	25	-	0,43	90	20
20	-	-	25	-	0,45	95	20
25	-	-	20	-	0,54	100	20
28	-	-	20	-	0,59	105	20
30	-	-	18	-	0,63	110	20
32	-	-	18	-	0,66	115	20
35	-	-	15	-	0,72	125	20
38	-	-	15	-	0,88	130	20
40	-	-	15	-	0,97	135	20
42	-	-	15	-	1,02	135	20
45	-	-	12	-	1,08	140	20
48	-	-	12	-	1,14	150	20
51	-	-	12	-	1,20	160	20
54	-	-	10	-	1,27	160	20
60	-	-	8	-	1,39	165	20
63,5	-	-	8	-	1,59	170	20
65	-	-	8	-	1,62	170	20
67	-	-	8	-	1,67	175	20
70	-	-	8	-	1,74	180	20
73	-	-	8	-	1,88	200	20
76	-	-	8	-	1,94	220	20
80	-	-	8	-	2,04	225	20
90	-	-	7	-	3,26	250	20
102	-	-	6	-	3,65	280	20
114	-	-	6	-	4,04	290	20
127	-	-	6	-	4,46	300	20
133	-	-	6	-	4,93	350	20
140	-	-	6	-	5,74	360	20
152	-	-	6	-	6,19	400	20
203	-	-	5	-	10,29	450	10
254	-	-	5	-	14,92	1200	10
305	-	-	5	-	18,69	1450	10
350	-	-	5	-	21,58	1750	6
404	-	-	4	-	26,72	2000	6



STRUTTURA / STRUCTURE / STRUCTURE AUFBAU / ESTRUCTURA

SOTTOSTRATO INNER LAYER COUCHE INTÉRIEURE SCHLAUCHEINLAGE CAPA INTERIOR	INSERTI REINFORCEMENT REINFORCEMENT EINLAGEN REFUERZOS	COPERTURA OUTER COVER COUCHE EXTERIEURE AUSSENSCHICHT CAPA EXTERIOR
<p>Liscio in gomma siliconica blu, resistente al calore e all'acqua di mare.</p> <p>Smooth, blue silicone rubber, heat and sea water resistant.</p> <p>Lisse en caoutchouc à base de silicone bleu, résistante à la chaleur et à l'eau de mer.</p> <p>Glatt aus blauem Silikon-Gummi, das gegenüber Hitze und Meerwasser beständig ist.</p> <p>Lisa en caucho siliconado azul, resistente al calor y al agua de mar.</p>	<p>Tessili, sintetici, resistenti alle temperature alte, doppia spirale d'acciaio incorporata.</p> <p>High temperature resistant, textile, synthetic yarns, embedded double steel spiral.</p> <p>Gâines textile, synthétiques, résistantes aux hautes températures, spirale en acier double incorporée.</p> <p>Mit Gewebe, das gegenüber hohen Temperaturen beständig ist, und 2 zwischen dem Gewebeeingebauten Stahlschrauben.</p> <p>Hilos textiles, sintéticos, resistentes a temperaturas altas, espiral en acero doble incorporada.</p>	<p>Liscia, in gomma siliconica blu, resistente al calore, agli agenti atmosferici e all'acqua di mare.</p> <p>Smooth, in blue silicone rubber, heat, weathering and sea water resistant.</p> <p>Lisse, en caoutchouc siliconé bleu, résistante à la chaleur, aux agents atmosphériques et à l'eau de mer.</p> <p>Glatt, aus blauem Silikon-Gummi, das gegenüber Hitze und Witterungseinwirkungen beständig ist.</p> <p>Lisa, en caucho siliconado azul, resistente al calor, a los agentes atmosféricos y al agua de mar.</p>



Sottostrato
Inner layer
Couche intérieure
Schlauchleinlage
Capa interior



Inserti
Reinforcement
Reinforcement
Einlagen
Refuerzos



Copertura
Outer cover
Couche extérieure
Außenschicht
Capa exterior



-60°C / +200°C
-76°F / +392°F

SANITARI / WC ULTRAFLEX

MARCATURA / MARKING / MARQUAGE / BESCHRIFTUNG / MARCATURA

EUROCORD®

SANITARI WC TESTED ISO 8099:2000 & UNI EN 13725:2014 - 5 YEARS LOW PERMEABILITY - ULTRAFLEX



- **ZERO ODOR PERMEABILITY**
- **EXTREMELY FLEXIBLE**
- **LONG LIFE USE**



IMPIEGO / USE / EMPLOI / EINSATZ / EMPLEO

Tubo idoneo allo scarico di rifiuti igienici all'interno delle imbarcazioni di diporto. Il suo sottostrato speciale impedisce la diffusione dei odori dallo scarico del WC. Estremamente flessibile grazie a dei ottimi raggi di curvatura. Adatto a spazi stretti e di difficile passaggio.

Ideal for toilet waste discharge in boats and yachts. The special inner layer prevents the odor propagation from the toilet drain. Extremely flexible thanks to very low bending radius. Suitable for narrow and of difficult access spaces.

Idéal pour l'évacuation des déchets de toilette dans des navires et bateaux de plaisance. Sa couche intérieure spéciale empêche la propagation des odeurs depuis les canalisations des toilettes. Extrêmement flexible grâce à des rayons de courbure très bas. Adapté aux espaces étroits et d'accès difficile.

Ideal für die Entsorgung von Toilettenabfällen auf Booten und Yachten. Die spezielle Innenschicht verhindert die Geruchsausbreitung aus dem Toilettenabfluss. Äußerst flexibel durch sehr geringen Biegeradius. Geeignet für enge und schwer zugängliche Räume.

Idóneo para la descarga de desechos del inodoro en barcos y embarcaciones de recreo. Por su capa interior especial previene la propagación desde el desagüe del inodoro. Extremadamente flexible gracias a radios de curvatura muy bajo. Adecuado para espacios reducidos y de paso difícil.

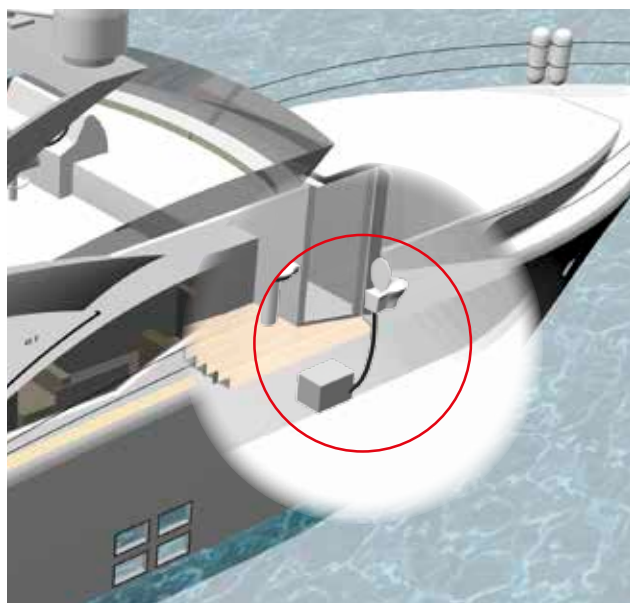

STRUTTURA / STRUCTURE / STRUCTURE AUFBAU / ESTRUCTURA

SOTTOSTRATO

INNER LAYER
COUCHE INTÉRIEURE
SCHLAUCHEINLAGE
CAPA INTERIOR

A

Gomma butilica nera.

Black, butyl rubber.

En caoutchouc butylique noir.

Aus schwarzem Butyl-Gummi.

En caucho butílico negro.

INSERTI

REINFORCEMENT
RENFORCEMENT
EINLAGEN
REFUERZOS

B

Tessili, sintetici ad alta tenacità e spirale metallica incorporata.

High tenacity textile synthetic yarns, embedded steel spiral.

Gâines textile synthétiques de haute ténacité, spirale en acier incorporée.

Synthetisches Gewebe mit hoher Reißfestigkeit und eingebauter Metallspirale.

Hilos textiles, sintéticos de alta tenacidad, espiral en acero incorporada.

COPERTURA

OUTER COVER
COUCHE EXTERIEURE
AUSSENSCHICHT
CAPA EXTERIOR

C

In gomma EPDM di colore grigio o bianco resistente agli agenti atmosferici, all'invecchiamento e all'ozono.

Gray or white EPDM rubber, antiabrasive, weathering resistant.

En caoutchouc EPDM de couleur grise ou blanche, antiabrasif, résistant aux agents atmosphériques.

Grauer oder weißer EPDM-Gummi, abriebfest, witterungsbeständig.

En caucho EPDM de color gris o blanco, antiabrasivo, resistente a los agentes atmosféricos.

							GRAY	WHITE
mm	mm	bar	bar	bar	g/m	mm	mt	mt
16	24	-	-	0,8	345	50	40	30
19	27	-	-	0,8	410	60	40	30
25	33	-	-	0,8	525	80	40	30
30	38	-	-	0,8	605	95	40	30
38	46,5	-	-	0,8	930	120	40	30
40	48,5	-	-	0,8	975	130	40	30
51	59	-	-	0,8	1215	175	40	30

IMBALLO: polietilene trasparente PACKAGING: transparent polyethylene
EMBALLAGE: polyéthylène transparent VERPACKUNG: transparentes Polyethylen
EMBALAJE: polietileno transparente



Sottostrato Inner layer Couche intérieure Schlaucheinlage Capa interior	Inserti Reinforcement Einlagen Refuerzos	Spirale Wire Spirale Spiral Espiral	Copertura Outer Cover Couche extérieure Außenschicht Capa exterior

-40°C / +120°C
-40°F / +248°F



- ✓ **EXTREMELY FLEXIBLE**
- ✓ **LOW COST**

IMPIEGO / USE / EMPLOI / EINSATZ / EMPLEO

Tubo idoneo allo scarico di rifiuti igienici all'interno delle imbarcazioni di diporto. Estremamente flessibile grazie a degli ottimi raggi di curvatura. Adatto a spazi stretti e di difficile passaggio.

Ideal for toilet waste discharge in boats and yachts. Extremely flexible thanks to very low bending radius. Suitable for narrow and of difficult access spaces.

Idéal pour l'évacuation des déchets de toilette dans des navires et bateaux de plaisance. Extrêmement flexible grâce à des rayons de courbure très bas. Adapté aux espaces étroits et d'accès difficile.

Schlauch geeignet zum Ablassen von Hygieneabfällen in Sportbooten. Durch die hervorragenden Biegeradien ist er extrem flexibel. Geeignet für enge und schwer zugängliche Räume.

Idóneo para la descarga de desechos del inodoro en barcos y embarcaciones de recreo. Extremadamente flexible gracias a radios de curvatura muy bajo. Adecuado para espacios reducidos y de paso difícil.

mm	mm	bar	bar	bar	g/m	mm	mt
12	3,0	7	-	0,85	180	25	30/60
14	3,0	6	-	0,85	200	30	30/60
16	3,1	6	-	0,85	225	35	30/60
18	3,1	6	-	0,85	280	40	30/60
20	3,1	5	-	0,85	340	50	30/60
22	3,2	5	-	0,85	370	55	30/60
25	3,2	5	-	0,85	510	60	30/60
30	3,5	4	-	0,85	600	70	30/60
32	3,9	4	-	0,85	650	75	30
35	4,2	4	-	0,85	730	80	30
38	4,4	4	-	0,85	800	90	30
40	4,5	3	-	0,85	870	95	30
45	5,1	3	-	0,80	1100	105	30
50	5,1	3	-	0,80	1200	125	30
60	6,5	2,5	-	0,70	1800	135	30
63	6,5	2,5	-	0,70	1950	150	30
70	7	2	-	0,70	2200	180	30
76	7	2	-	0,70	2500	195	30
80	7,5	2	-	0,70	2700	220	30
90	7,5	2	-	0,60	3000	260	30
102	8	2	-	0,60	3400	300	30



**STRUTTURA / STRUCTURE / STRUCTURE
AUFBAU / ESTRUCTURA**

COPERTURA
OUTER COVER
COUCHE EXTERIEURE
AUSSCHICHT
CAPA EXTERIOR

PVC bianco opaco/grigio.
White PVC opaque/grey.
En PVC de couleur blanche opaque/gris.
Mattweißes/grau PVC.
En PVC de color blanco opaco/gris.

SPIRALE
WIRE
SPIRALE
SPIRALE
ESPIRAL

Spirale metallica incorporata.
Embedded steel spiral.
Spirale en acier incorporée.
Mit eingebauter Metallspirale.
Espiral en acero incorporada.

IMBALLO: polietilene bianco **PACKAGING:** White polyethylene **EMBALLAGE:** polyéthylène blanc **VERPACKUNG:** Weiß Polyethylen **EMBALAJE:** polietileno blanco



Spirale
Wire
Spirale
Spiral



Copertura
Outer Cover
Couche extérieure
Außenschicht
Capa exterior



-5°C / +60°C
+23°F / +140°F



- ✓ **HIGH ANTI-ODOUR RESISTANCE**
- ✓ **STEEL WIRE REINFORCEMENT**
- ✓ **LIGHTER IN WEIGHT, SUPERIOR FLEXIBILITY, VALUE FOR MONEY VERSUS RUBBER HOSES**



IMPIEGO / USE / EMPLOI / EINSATZ / EMPLEO

Studiato appositamente per lo scarico di rifiuti igienici nelle toilettes delle imbarcazioni di diporto e caravan. Vantaggi concreti in paragone con tubi equivalenti in gomma: flessibilità e leggerezza superiore, massima impermeabilità ai cattivi odori, economicamente vantaggiosi.

Specially designed for use of special compound for toilet waste discharge in boats, yachts and caravans. Concrete advantages versus equivalent rubber hoses: lighter in weight, superior flexibility and anti-odour resistance, value for money.

Spécialement conçu grâce à un composé spécial pour l'évacuation des déchets de toilette aux bateaux de plaisance et caravanes. Avantages concrets vis-à-vis les tuyaux équivalents en caoutchouc: souplesse et légèreté supérieures, imperméabilité optimale contre les odeurs, plus économique.

Speziell entwickelt für den Einsatz zur Entsorgung von Hygieneabfällen in den Toiletten von Sportbooten und Wohnwagen. Konkrete Vorteile im Vergleich zu gleichwertigen Gummischläuchen: überlegene Flexibilität und extreme Leichtigkeit, maximale Undurchlässigkeit gegenüber schlechten Gerüchen und wirtschaftlich vorteilhaft.

Diseñado específicamente por medio de un compuesto especial para la descarga de los desechos de inodoro en barcos y embarcaciones de recreo y caravanas. Ventajas concretas comprobando con mangueras equivalentes en caucho: mayor ligereza ligereza e flexibilidad, máxima impermeabilidad antiolores, más económico.

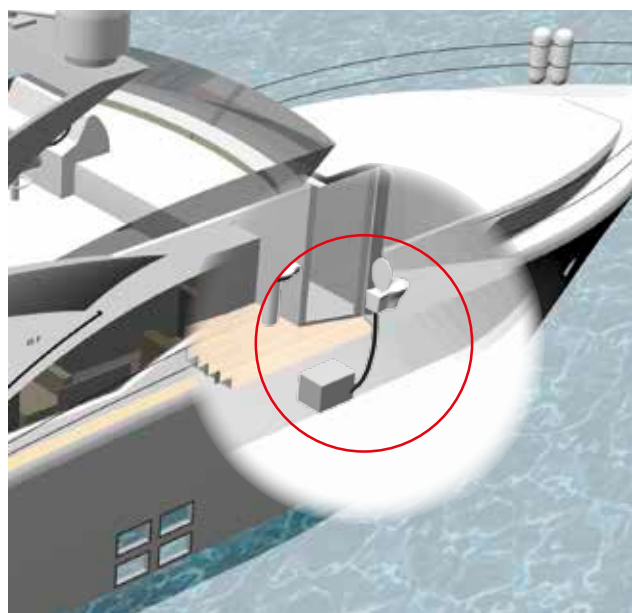

STRUTTURA / STRUCTURE / STRUCTURE AUFBAU / ESTRUCTURA

MESCOLA INTERNA
INTERNAL COMPOSITION
COMPOSÉ INTERNE
INTERNE VERBINDUNG
COMPUESTO INTERIOR

Miscela speciale in PVC che impedisce la propagazione dei cattivi odori.

Special anti-odour PVC compound.

Composé spécial en PVC anti-odeur.

Spezielle PVC-Verbindung, die die Verbreitung von schlechten Gerüchen verhindert.

Compuesto especial en PVC antiolores.

SPIRALE
WIRE
SPIRALE
SPIRAL
ESPIRAL

Spirale in acciaio ultra-flessibile incorporata.

Embedded steel spiral, ultra flexible.

Spirale en acier, ultra flexible, incorporée.

Eingebaute ultraflexible Stahlschleife.

Espirale en acero, ultra flexible, incorporada.

COPERTURA
OUTER COVER
COUCHE EXTERIEURE
AUßENSCHICHT
CAPA EXTERIOR

Di colore grigio, liscia, resistente agli agenti atmosferici.

Gray colour, smooth, weathering resistant.

En couleur grise, lisse, résistante aux agents atmosphériques.

Graue Farbe, glatt, witterungsbeständig.

En color gris, lisa, resistente a los agentes atmosféricos.

mm	mm	bar	bar	bar	g/m	mm	mt
20	27	8,5	24	0,9	340	30	25
25	33	8,5	24	0,9	520	38	25
30	38,4	8	24	0,9	630	60	25
38	47	8	24	0,9	800	76	25
40	50	8	24	0,9	950	80	25
50	60	8	24	0,9	1020	100	25

IMBALLO: polietilene bianco PACKAGING: White polyethylene EMBALLAGE: polyéthylène blanc
VERPACKUNG: Weiß Polyethylen EMBALAJE: polietileno blanco

Sottostrato
Inner layer
Couche intérieure
Schlaucheinlage
Capa interior

Spirale
Wire
SPIRALE
Spiral
ESPIRAL

Copertura
Outer Cover
Couche extérieure
Außenschicht
Capa exterior

-5°C / +60°C
+23°F / +140°F



- EXTRA FLEXIBLE
- MULTIPURPOSE
- FOOD GRADE 

 **IMPIEGO / USE / EMPLOI / EINSATZ / EMPLEO**









Tubo in PVC flessibile trasparente con spirale d'acciaio incorporata. Idoneo per l'aspirazione e mandata d'acqua di mare, fluidi inerti e liquidi alimentari secondo la Direttiva UE 10/ 2011 per simulanti A,B,C. Principali settori d'impiego sono l'agricoltura, l'industria alimentare e chimica, la cantieristica navale, gli impianti di drenaggio, autospurghi e pompe d'aspirazione.

PVC flexible transparent hose with embedded steel spiral. Suitable for suction & delivery of sea water, inactive fluids and liquid foodstuffs in accordance with the Directive EU 10/2011 for stimulants A,B,C. Used in agriculture, construction, food, naval, chemical industry in drainage and discharge applications.

Tuyau en PVC transparent, flexible, avec spirale en acier incorporée. Conçu pour l'aspiration et le refoulement de l'eau de mer, des fluides inerts et liquides alimentaires conformément à la Directive UE 10/2011 pour les simulants A,B,C. Utilisé en agriculture, industrie alimentaire, navale, chimique, drainage et applications de déchargement en général.

Transparenter flexibler PVC-Schlauch mit eingearbeiteter Stahlspirale. Geeignet zum Absaugen und Fördern von Meerwasser, inerten Flüssigkeiten und Lebensmittel Flüssigkeiten gemäß der EU-Richtlinie 10/2011 für Simulanzien A,B,C. Die Haupteinsatzbereiche sind die Landwirtschaft, die Lebensmittel- und Chemieindustrie, der Schiffbau, Entwässerungssysteme, Saugfahrzeuge und Saugpumpen.

Manguera en PVC, transparente, flexible con espiral de acero incorporada. Adecuada para la aspiración y entrega del agua de mar, fluidos inertes y líquidos alimenticios según la Directiva UE 10/2011 SIM para simulantes A,B,C. Utilizado en agricultura, industria alimenticia, naval, química, drenaje y aplicaciones de descarga en general.

 mm	 mm	 bar	 bar	 bar	 g/m	 mm	 mt
10	3,0	7	-	0,85	160	20	30/60
12	3,0	7	-	0,85	180	25	30/60
14	3,0	6	-	0,85	200	30	30/60
16	3,1	6	-	0,85	225	35	30/60
18	3,1	6	-	0,85	280	40	30/60
20	3,1	5	-	0,85	340	50	30/60
22	3,2	5	-	0,85	370	55	30/60
25	3,2	5	-	0,85	510	60	30/60
30	3,5	4	-	0,85	600	70	30/60
32	3,9	4	-	0,85	650	75	30
35	4,2	4	-	0,85	730	80	30
38	4,4	4	-	0,85	800	90	30
40	4,5	3	-	0,85	870	95	30
45	5,1	3	-	0,80	1100	105	30
50	5,1	3	-	0,80	1200	125	30
60	6,5	2,5	-	0,70	1800	135	30
63	6,5	2,5	-	0,70	1950	150	30
70	7	2	-	0,70	2200	180	30
76	7	2	-	0,70	2500	195	30
80	7,5	2	-	0,70	2700	220	30
90	7,5	2	-	0,60	3000	260	30
102	8	2	-	0,60	3400	300	30

 **STRUTTURA / STRUCTURE / STRUCTURE
AUFBAU / ESTRUCTURA**

COPERTURA
OUTER COVER
COUCHE EXTERIEURE
AUSSENSCHICHT
CAPA EXTERIOR



Parete trasparente in PVC, con spirale d'acciaio incorporata.
PVC transparent wall, embedded steel spiral reinforcement.
Paroi transparente en PVC, renforcement par spirale en acier incorporée.
Transparente PVC-Wand, mit eingearbeiteter Stahlspirale.
Pared transparente en PVC, refuerzo por una espiral de acero incorporada.

SPIRALE
WIRE
SPIRALE
SPIRAL
ESPIRAL



Spirale metallica incorporata.
Embedded steel spiral.
Spirale métallique incorporée.
Mit eingebauter Metallschpirale.
Espiral metálica incorporada.

IMBALLO: polietilene bianco **PACKAGING:** White polyethylene **EMBALLAGE:** polyéthylène blanc
VERPACKUNG: Weiß Polyethylen **EMBALAJE:** polietileno blanco

NORME / NORMS / NORMES / NORMEN / NORMAS:
2007/19/EC SIMULANTS TYPE A,B,C ISO 1307 DIRECTIVE EU 10/2011 SIMULANTS TYPE A,B,C

Copertura
Outer Cover
Couche extérieure
Außenschicht
Capa exterior





Spirale
Wire
Spirale
Spiral
Espiral



-5°C / +60°C
+23°F / +140°F



- **VERY FLEXIBLE**
- **FOOD GRADE** 
- **MULTIPURPOSE**



IMPIEGO / USE / EMPLOI / EINSATZ / EMPLEO









Idoneo alla mandata ed aspirazione di acqua, fluidi inerti e liquidi alimentari secondo la Direttiva UE 10/2011 per simulanti A,B,C. Particolarmente indicato come flessibile di collegamento per la pompa di sentina.

Suitable for suction & delivery of water, inert fluids and liquid foodstuffs in accordance with Directive EU 10/2011 for simulants A,B,C. Recommended as flexible link to the bilge pump.

Adapté pour l'aspiration et refoulement d'eau, des fluides inertes et des liquides alimentaires conformément à la Directive UE 10/2011 pour les simulants A,B,C. Recommandé comme pièce de raccordement pour la pompe de cale.

Geeignet für die Zufuhr und das Absaugen von Wasser, inerten Flüssigkeiten und Lebensmittel Flüssigkeiten; gemäß der EU-VERORDNUNG Nr. 10/2011 A-B-C Simulanzen. Besonders geeignet als flexibles Verbindungsstück für die Lenzpumpe.

Adecuado para la aspiración y entrega de agua, fluidos inertes y líquidos alimenticios según la Directiva UE 10/2011 para los simulantes A,B,C. Recomendado como conexión para las bombas de sentina.

 mm	 mm	 bar	 bar	 bar	 g/m	 mm	 mt
20	2,7	-	28	0,80	240	85	50
25	2,9	-	22	0,80	300	112	50
30	3,1	-	21	0,80	345	135	50
32	3,2	-	20	0,80	370	144	50
35	3,2	-	19	0,80	415	157	50
38	3,3	-	18	0,80	470	171	50
40	3,5	-	18	0,80	505	180	50
45	3,5	-	17	0,80	570	202	50
50	3,8	-	15	0,80	690	225	50
60	4,0	-	13	0,70	825	270	50
70	4,5	-	12	0,70	1080	315	50
75	4,6	-	12	0,70	1260	337	50
80	4,8	-	12	0,60	1400	360	50
90	5,1	-	11	0,60	1620	405	25
100	5,9	-	11	0,60	1850	459	25
110	6,1	-	11	0,50	2250	495	25
120	6,3	-	10	0,40	2700	540	25
125	6,6	-	10	0,40	2880	562	25
150	7,0	-	9	0,30	3870	675	25
200	8,5	-	7	0,20	5950	900	10



STRUTTURA / STRUCTURE / STRUCTURE AUFBAU / ESTRUCTURA

COPERTURA

OUTER COVER
COUCHE EXTERIEURE
AUßENSCHICHT
CAPA EXTERIOR

Parete in PVC flessibile trasparente gialla con spirale in PVC rigido antiurto.
PVC yellow transparent flexible wall, rigid PVC spiral reinforcement.
Paroi en PVC flexible, transparente jaune, renforcement par spirale en PVC rigide.
Gelbe transparente flexible PVC-Wand mit stoßfester Hart-PVC-Spirale.
Paredes en PVC flexible, transparente amarilla, refuerzo por espiral en PVC rigida.

SPIRALE

WIRE
SPIRALE
SPIRAL
ESPIRAL

Spirale gialla antiurto.
Yellow shock resistant pvc spiral.
Spirale jaune anti-choc.
Mit stoßfester gelber Spirale.
Espiral amarilla antichoque.

IMBALLO: polietilene bianco PACKAGING: White polyethylene EMBALLAGE: polyéthylène blanc
VERPACKUNG: Weiß Polyethylen EMBALAJE: polietileno blanco
NORME / NORMS / NORMES / NORMEN / NORMAS:
2007/19/EC SIMULANTS TYPE A,B,C ISO 1307 DIRECTIVE EU 10/2011 SIMULANTS TYPE A,B,C

Copertura
Outer Cover
Couche extérieure
Außenschicht
Capa exterior

Spirale
Wire
Spirale
Spiral
Espiral

-5°C / +60°C
+23°F / +140°F

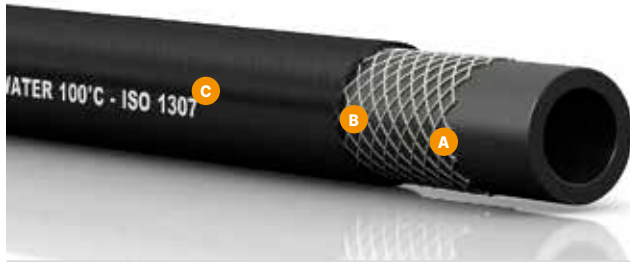

- SEA WATER RESISTANT
- LIGHT AND FLEXIBLE
- HOT WATER RESISTANT



IMPIEGO / USE / EMPLOI / EINSATZ / EMPLEO

Tubo flessibile per mandata in pressione di acqua di mare, acqua calda e liquidi leggermente corrosivi in attrezzature ed impianti di vario genere.

Flexible hose for the delivery of sea water, hot water and slightly corrosive liquids under pressure in equipment and plants of various kinds.

Tuyau souple pour le refoulement sous pression d'eau de mer, d'eau chaude et de liquides légèrement corrosifs dans des équipements et des installations de différentes typologies.

Flexibler Schlauch für die Druckzufuhr von Meerwasser, heißem Wasser und leicht korrosiven Flüssigkeiten in Geräten und Anlagen unterschiedlicher Art.

Tubo flexible para impulsión a presión de agua de mar, agua caliente y líquidos ligeramente corrosivos en equipos e instalaciones de diverso tipo.

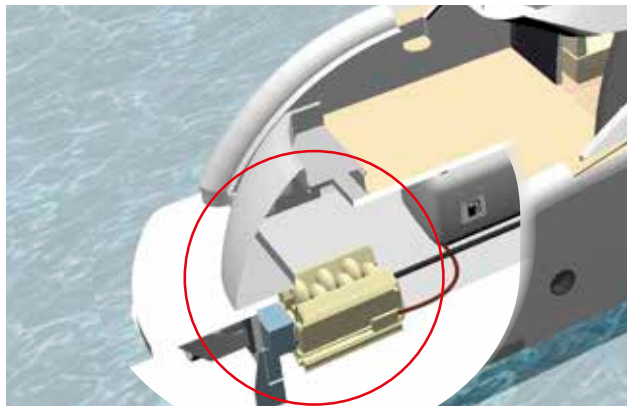

STRUTTURA / STRUCTURE / STRUCTURE STRUKTUR / ESTRUCTURA

SOTTOSTRATO
INNER LAYER
COUCHE INTÉRIEURE
SCHLAUCHEINLAGE
CAPA INTERIOR

Liscio, nero, in gomma EPDM.
Smooth, black, in EPDM rubber.
Lisse, noir, en caoutchouc EPDM.
Glatt, schwarz, aus EPDM-Gummi.
Lisa, negra, en caucho EPDM.

INSERTI
REINFORCEMENT
RENFORCEMENT
EINLAGEN
REFUERZOS

Tessili sintetici.
Textile synthetic yarns.
Gaines textiles synthétiques.
Synthetisches Textilgewebe.
Hilos textiles sintéticos.

COPERTURA
OUTER COVER
COUCHE EXTERIEURE
AUSSENSCHICHT
CAPA EXTERIOR

Liscia in gomma EPDM di colore nero resistente all'acqua di mare, alla temperatura, all'abrasione, agli agenti atmosferici.
Black, smooth, EPDM rubber, sea water, high temperature and weathering resistant.
En EPDM, lisse, noir, résistante à l'eau de mer, haute température et aux agents atmosphériques.
Schwarzer, glatter EPDM-Gummi, beständig gegen Seewasser, hohe Temperaturen und Witterung.
En EPDM, lisa, negra, resistente al agua de mar, alta temperatura y a los agentes atmosféricos.

mm	mm	bar	bar	bar	g/m	mm	mt
5	10,5	10	30	-	82	50	100
5	11	10	30	-	93	50	100
6	12	10	30	-	102	60	100
7	13	10	30	-	120	70	100
8	15	10	30	-	160	80	100
10	17	10	30	-	185	100	100
12	17	10	30	-	155	120	100
13	19	10	30	-	180	130	100
14	21	10	30	-	230	140	50
15	21	10	30	-	205	150	50
15	23	10	30	-	360	150	50
19	26	10	30	-	310	190	50
20	30	10	30	-	480	200	50
22	30	10	30	-	390	220	50
25	33	10	30	-	550	250	50
25	35	10	30	-	610	250	50

IMBALLO: polietilene trasparente **PACKAGING:** transparent polyethylene
EMBALLAGE: polyéthylène transparent **VERPACKUNG:** transparentes Polyethylen
EMBALAJE: polietileno transparente



Sottostrato
Inner layer
Couche intérieure
Schlaucheinlage
Capa interior



Inserti
Reinforcement
Renforcement
Einlagen
Refuerzos



Copertura
Outer Cover
Couche extérieure
Außenschicht
Capa exterior



-40°C / +125°C
-40°F / +257°F



- SEA WATER RESISTANT
- HOT WATER RESISTANT



IMPIEGO / USE / EMPLOI / EINSATZ / EMPLEO

Idoneo per mandata di acqua di mare calda mista a vapore e fluidi caldi non corrosivi.

Suitable for the delivery of hot sea water mixed with steam and non corrosive hot liquids.

Idéal pour le refoulement d'eau de mer chaude mixte avec vapeur et fluides chauds non corrosifs.

Geeignet für den Transport von Meerwasser gemischt mit Dampf und nicht korrosiven heißen Flüssigkeiten.

Idóneo para la entrega de agua de mar caliente mista con vapor y fluidos calientes no corrosivos.

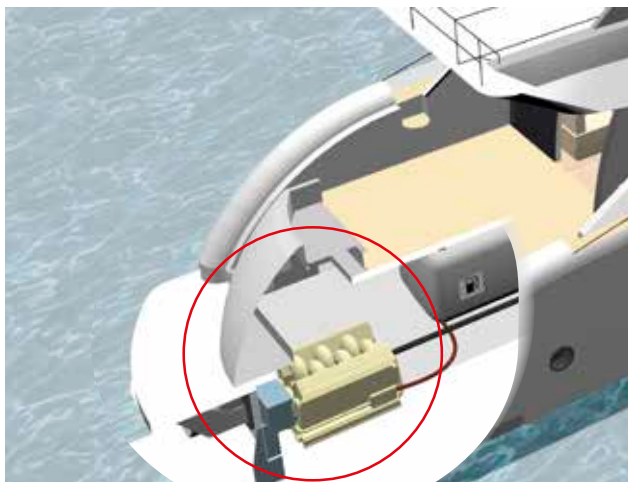

STRUTTURA / STRUCTURE / STRUCTURE STRUKTUR / ESTRUCTURA

SOTTOSTRATO

INNER LAYER
COUCHE INTÉRIEURE
SCHLAUCHEINLAGE
CAPA INTERIOR

A

Liscio in gomma EPDM di colore nero.

Smooth black EPDM rubber.

Lisse en caoutchouc EPDM de couleur noire.

Glatt aus schwarzem EPDM-Gummi.

Lisa de goma EPDM de color negro.

INSERTI

REINFORCEMENT
REINFORCEMENT
EINLAGEN
REFUERZOS

B

Tessili sintetici.

Textile synthetic yarns.

Gâines textile synthétiques.

Synthetisches Textilgewebe.

Hilos textiles sintéticos.

COPERTURA

OUTER COVER
COUCHE EXTERIEURE
AUSSENSCHICHT
CAPA EXTERIOR

C

Gomma EPDM di colore nero resistente al calore, agli agenti atmosferici ed all'invecchiamento. **Superficie:** smooth with cloth impression.

Black, EPDM rubber, high temperature, weathering and ageing resistant. **Outer layer:** smooth with fabric impression.

En EPDM, noire, résistante à la haute température aux agents atmosphériques et au vieillissement. **Couche extérieure:** lisse entoillée.

Schwarzer EPDM-Gummi. Beständig gegen hohe Temperaturen, Witterung und Alterung. **Außenfläche:** Glatt mit Stoffeindruck.

En EPDM, negra, resistente al alta temperatura, a los agentes atmosféricos y al envejecimiento. **Capa exterior:** lisa con impresión de tela.

mm	mm	bar	bar	bar	g/m	mt	
10	20	10	30	-	346	100	40
12	22	10	30	-	392	120	40
15	25	10	30	-	461	150	40
18	28	10	30	-	529	180	40
19	30	10	30	-	619	190	40
20	30	10	30	-	575	200	40
25	35	10	30	-	667	250	40
30	41	10	30	-	897	300	40
35	48	10	30	-	1260	350	40
40	54	10	30	-	1423	400	40
45	61	10	30	-	1864	450	40
50	68	10	30	-	2231	510	40
60	82	10	30	-	3443	600	40

IMBALLO: polietilene trasparente **PACKAGING:** transparent polyethylen
EMBALLAGE: polyéthylène transparent **VERPACKUNG:** transparentes Polyethylen
EMBALAJE: polietileno transparente



Sottostrato
Inner layer
Couche intérieure
Schlaucheinlage
Capa interior



Inserti
Reinforcement
Reinforcement
Einlagen
Refuerzos



Copertura
Outer Cover
Couche extérieure
Außenschicht
Capa exterior



-40°C / +125°C
-40°F / +257°F



- SEA WATER RESISTANT
- HOT WATER RESISTANT
- VERY LOW BENDING RADIUS



IMPIEGO / USE / EMPLOI / EINSATZ / EMPLEO

Idoneo alla mandata ed aspirazione di acqua di mare e acqua calda anche con contenuto chimico in concentrazione bassa. Può essere raccordato come flessibile per le pompe di calore e di autoclavi.

Ideal for the suction & delivery of sea water and hot water even with low concentration chemical content. Can be used as flexible connection for heating pumps and autoclaves.

Idéal pour l'aspiration et le refoulement de l'eau de mer et d'eau chaude même au contenu chimique de concentration basse. Peut servir de connexion flexible pour les pompes thermiques.

Ideal zum Ansaugen und Fördern von Meerwasser und heißem Wasser, auch mit geringem Chemikaliengehalt. Als flexible Verbindung für Wärmepumpen und Autoklaven einsetzbar.

Idóneo para aspiración y entrega del agua de mar, de agua caliente también con contenido químico en concentración baja. Puede servir de conexión para bombas térmicas y autoclaves.



STRUTTURA / STRUCTURE / STRUCTURE STRUKTUR / ESTRUCTURA

SOTTOSTRATO

INNER LAYER
COUCHE INTÉRIEURE
SCHLAUCHEINLAGE
CAPA INTERIOR

Liscio in gomma EPDM di colore nero, resistente al calore.

Smooth black EPDM rubber, resistant to heat.

Lisse en caoutchouc EPDM de couleur noire, résistant à la chaleur.

Glatt aus schwarzem hitzebeständigen EPDM-Gummi.

Lisa de goma EPDM de color negro, resistente al calor.

INSERTI

REINFORCEMENT
RENFORCEMENT
EINLAGEN
REFUERZOS

Tessili sintetici ad alta tenacità, con spirale in acciaio incorporata.

Textile synthetic yarns with embedded steel spiral.

Gâines textiles synthétiques avec spirale en acier incorporée.

Synthetische Textilgarne mit eingebetteter Stahlschpirale.

Hilos textiles sintéticos con espiral en acero incorporada.

COPERTURA

OUTER COVER
COUCHE EXTERIEURE
AUßENSCHICHT
CAPA EXTERIOR

Gomma EPDM di colore nero resistente al calore, all'acqua di mare, agli agenti atmosferici ed all'invecchiamento. **Superficie:** liscia ad impressione tela.

Black, EPDM rubber, high temperature, weathering and ageing resistant. **Outer layer:** smooth with cloth impression
En EPDM, noire, résistante à la haute température aux agents atmosphériques et au vieillissement. **Couche extérieure:** lisse entoïlée.

Schwarzer EPDM-Gummi. Beständig gegen hohe Temperaturen, Witterung und Alterung. **Außenfläche:** Glatt mit Stoffeindruck.

En EPDM, negra, resistente al alta temperatura, a los agentes atmosféricos y al envejecimiento. **Capa exterior:** lisa con impresión de tela.

mm	mm	bar	bar	bar	g/m	mm	mt
16	26	10	30	0,92	487	64	40
19	29	10	30	0,92	557	76	40
20	30	10	30	0,92	580	80	40
25	35	10	30	0,92	700	100	40
30	40	10	30	0,92	800	120	40
32	43	10	30	0,92	1000	128	40
35	46	10	30	0,92	1090	140	40
38	49	10	30	0,92	1200	152	40
40	51	10	30	0,92	1310	160	40
45	57	10	30	0,92	1610	180	40
50,8	63	10	30	0,92	1790	203	40
60	72	10	30	0,92	1986	270	40
70	82	10	30	0,92	2426	300	40
76	90	10	30	0,92	3075	300	40
80	94	10	30	0,92	3230	320	40
102	116	10	30	0,92	4050	400	40

IMBALLO: polietilene trasparente PACKAGING: transparent polyethylene

EMBALLAGE: polyéthylène transparent VERPACKUNG: transparentes Polyethylen

EMBALAJE: polietileno transparente



Sottostrato
Inner layer
Couche intérieure
Schlaucheinlage
Capa interior



Inserti
Reinforcement
Renforcement
Einlagen
Refuerzos



Copertura
Outer Cover
Couche extérieure
Außenschicht
Capa exterior



-40°C / +125°C
-40°F / +257°F



• **HOT WATER**



IMPIEGO / USE / EMPLOI / EINSATZ / EMPLEO

Idoneo alla mandata di soluzione di acqua calda e liquido antigelo. Particolarmente utilizzato come collegamento flessibile nel circuito di raffreddamento dei motori degli autoveicoli.

For conveying hot water mixed anti-freeze liquids for cooling of thermal motors in the automobile sector and industry.

Pour le passage d'eau chaude et antigel dans les systems de refroidissement des moteurs thermiques secteur automobile et industrie.

Besonders geeignet als kühlerschlauch für kraftfahrzeuge.

Para el paso de agua caliente y líquido anticongelante en los motores, sector auto e industria.

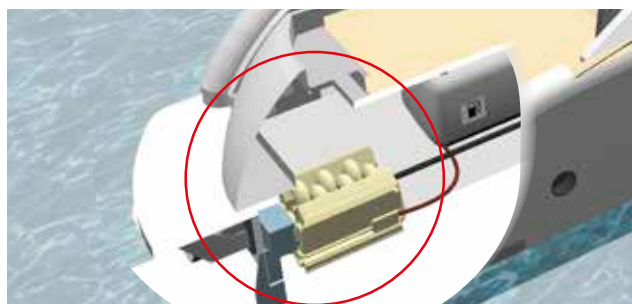

**STRUTTURA / STRUCTURE / STRUCTURE
STRUKTUR / ESTRUCTURA**

SOTTOSTRATO

INNER LAYER
COUCHE INTÉRIEURE
SCHLAUCHEINLAGE
CAPA INTERIOR

A

Gomma EPDM di colore nero.
Heat and anti-freeze liquid resistant EPDM rubber.
Caoutchouc en EPDM résistant à la chaleur et au liquide antigel.
Epdm-gummi, hitze- und kühlmittelbeständig.
Caucho en EPDM, resistente al liquido anticongelante y al calor.

INSERTI

REINFORCEMENT
RENFORCEMENT
EINLAGEN
REFUERZOS

B

Inserti di fibre tessili sintetiche ad alta tenacità.
High tenacity textile synthetic yarns.
Gaines textiles synthétiques de haute ténacité.
Hochfeste synthetische Textilgarne.
Hilos textiles, sintéticos de alta tenicidad.

COPERTURA

OUTER COVER
COUCHE EXTERIEURE
AUSSENSCHICHT
CAPA EXTERIOR

C

Gomma EPDM di colore nero resistente agli agenti atmosferici ed all'invecchiamento.
Superficie: liscia ad impressione tela.
Black, EPDM rubber, high temperature, weathering and ageing resistant. **Outer layer:** corrugated.
En EPDM, noire, résistante à la haute température aux agents atmosphériques et au vieillissement. **Couche extérieure:** ondulée.
Schwarzer EPDM-Gummi. Beständig gegen hohe Temperaturen, Witterung und Alterung. **Außenfläche:** Gewellt.
En EPDM, negra, resistente al alta temperatura, a los agentes atmosféricos y al envejecimiento. **Capa exterior:** corrugada.

mm	mm	bar	bar	bar	g/m	mm	mt
18	24	4	12	-	281	180	40
20	26	4	12	-	307	200	40
22	28	4	12	-	334	220	40
25	32	4	12	-	423	250	40
28	36	4	12	-	573	280	40
30	38	4	12	-	609	300	40
32	40	4	12	-	645	320	40
35	43	4	12	-	699	350	40
38	46	4	12	-	753	380	40
40	48	4	12	-	789	400	40
42	50	4	12	-	825	420	40
45	54	4	12	-	990	450	40
50	60	4	12	-	1200	510	40
55	65	4	12	-	1280	550	40
60	70	4	12	-	1493	600	40
70	81	4	12	-	1906	700	20
80	92	4	12	-	2368	800	20
90	102	4	12	-	2457	900	20
102	112	4	12	-	2549	1020	20

IMBALLO: polietilene trasparente **PACKAGING:** transparent polyethylene
EMBALLAGE: polyéthylène transparent **VERPACKUNG:** transparentes Polyethylen
EMBALAJE: polietileno transparente

NORME / NORMS / NORMES / NORMEN / NORMAS: ISO 1307

Sottostrato
Inner layer
Couche Intérieure
Schlaucheinlage
Capa interior

Inserti
Reinforcement
Renforcement
Einlagen
Refuerzos

Copertura
Outer Cover
Couche extérieure
Außenschicht
Capa exterior

-40°C / +125°C
-40°F / +257°F

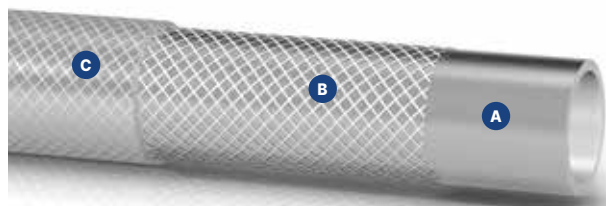

- ✓ **FOR SHOWER**
- ✓ **FOOD GRADE**

IMPIEGO / USE / EMPLOI / EINSATZ / EMPLEO

Tubo idoneo alla mandata di liquidi alimentari secondo la DIRETTIVA UE 10/2011 per i simulanti A,B,C. Indicato come flessibile nelle doccine.

Hose suitable for the delivery of liquid foodstuffs in accordance with the EU DIRECTIVE 10/2011 for simulants type A,B,C. Suitable for shower use.

Tuyau idéal pour le refoulement des liquides alimentaires selon la DIRECTIVE UE 10/2011 pour les simulants A,B,C, et aussi pour usage dans la douche.

Schlauch geeignet für die Förderung von flüssigen Lebensmitteln gemäß EU-RICHTLINIE 10/2011 für Simulanzien vom Typ A, B, C. Geeignet für die Verwendung bei Duschen.

Manguera idónea para la entrega de líquidos alimenticios según la DIRECTIVA UE 10/ 2011 para los simulantes A,B,C, y también para la ducha.

mm	mm	bar	bar	bar	g/m	mm	mt
5	3,0	20	60	-	81	14	100
6	3,0	20	60	-	83	15	100
7	3,0	20	60	-	119	20	100
8	3,0	20	60	-	117	26	100
10	3,0	15	45	-	138	35	100
12	3,0	10	30	-	159	36	100
13	3,0	10	30	-	169	50	100
15	3,0	10	30	-	190	60	50
16	3,0	10	30	-	201	62	50
19	3,5	10	30	-	280	70	50
22	4,0	8	24	-	374	90	50
25	4,0	8	24	-	417	110	50
30	4,0	7	21	-	490	175	50
32	4,5	7	21	-	560	195	50
35	5,0	7	21	-	686	270	50
38	5,0	5	15	-	743	310	50
40	5,0	5	15	-	777	360	50
45	5,0	5	15	-	840	425	50
50	5,0	5	15	-	949	450	50



STRUTTURA / STRUCTURE / STRUCTURE
AUFBAU / ESTRUCTURA

SOTTOSTRATO INNER LAYER COUCHE INTERIEURE SCHLAUCHEINLAGE CAPA INTERIOR	INSERTI REINFORCEMENT REINFORCEMENT EINLAGEN REFUERZOS	COPERTURA OUTER COVER COUCHE EXTERIEURE AUSSENSCHICHT CAPA EXTERIOR
A	B	C
PVC trasparente, qualità alimentare. Clear transparent PVC, food grade. PVC transparent incolore, qualité alimentaire. Klar transparentes PVC, geeignet für Lebensmittel. PVC transparente incolor, calidad alimenticia.	Tessili sintetici. Textile synthetic yarns. Gaïnes textiles synthétiques. Synthetische Textilgarne. Hilos textiles sintéticos.	PVC Trasparente. Transparent PVC. PVC Transparent. Aus transparentem PVC. PVC Transparente.

IMBALLO: polietilene trasparente PACKAGING: transparent polyethylene
EMBALLAGE: polyéthylène transparent VERPACKUNG: transparentes Polyethylen
EMBALAJE: polietileno transparente

Sottostrato
Inner layer
Couche intérieure
Schlaucheinlage
Capa interior

Inserti
Reinforcement
Reinforcement
Einlagen
Refuerzos

Copertura
Outer Cover
Couche extérieure
Außenschicht
Capa exterior

-5°C / +60°C
+23°F / +140°F



- **TOTALLY RECYCLABLE**
- **VERY GOOD FLEXIBILITY**



IMPIEGO / USE / EMPLOI / EINSATZ / EMPLEO

Tubo in LDPE per uso alimentare, idoneo al passaggio di acqua sia calda che fredda. Prodotto secondo normativa FDA title 21 Parts 170 to 199 item 177.2600 Conforme DM 174, CE 1935/2004 e UE 10/2011

LDPE hose for food use, suitable for the passage of both hot and cold water. Produced according to FDA-title 21 parts 170 to 199 item 177.2600 and DM 174, CE 1935/2004 and EU 10/2011.

Tuyau en LDPE pour usage alimentaire, adapté au passage d'eau chaude et froide. Production conforme à la norme FDA title 21 Parts 170 to 199 item 177.2600 Conforme DM 174, CE 1935/2004 et UE 10/2011.

LDPE Schlauch geeignet für den Lebensmittelbereich, geeignet für den Durchgang sowohl von heißem als auch von kaltem Wasser. Hergestellt gemäß den FDA-Vorschriften Titel 21 Teile 170 bis 199 Pos. 177.2600 entsprechend DM 174, CE 1935/2004 und EU 10/2011.

Manguera LDPE para uso alimenticio, apta para el paso de agua fría y caliente. Producido conforme a la normativa FDA título 21, partes 170 a 199 partida 177.2600 y DM 174, CE 1935/2004 y UE 10/2011.

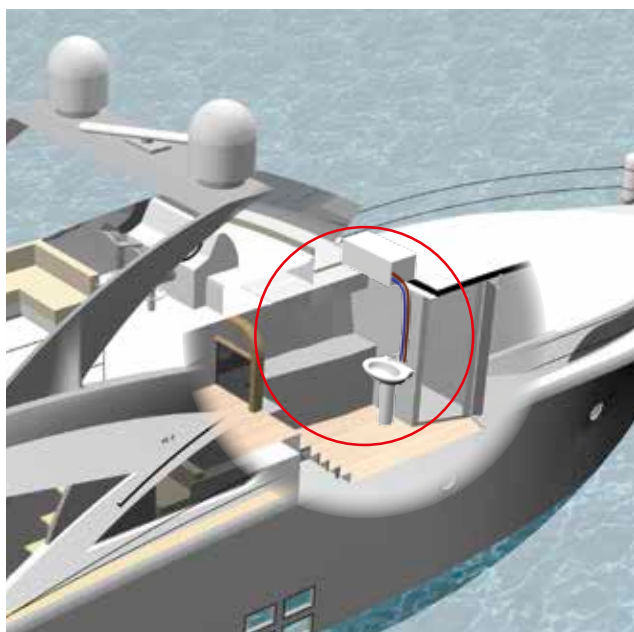

STRUTTURA / STRUCTURE / STRUCTURE STRUKTUR / ESTRUCTURA

MATERIALE

MATERIAL
MATERIAU
MATERIAL
MATERIAL



In polietilene a bassa densità conforme al passaggio di liquidi alimentari. Colore rosso o blu.

Low-density PE polyethylene for liquids foodstuffs. In red and blue colour.

En polyéthylène à basse densité conforme au passage de liquides alimentaires. Rouge et bleu.

Hergestellt aus nachgiebigem Polyethylen mit niedriger Dichte zum Durchtritt von Nahrungsfüssigkeiten. Rot und Blau.

Polietileno PE de baja densidad para líquidos productos alimenticios. Rojo y azul.

IMBALLO: polietilene trasparente **PACKAGING:** transparent polyethylene
EMBALLAGE: polyéthylène transparent **VERPACKUNG:** transparentes Polyethylen
EMBALAJE: polietileno transparente

mm	mm	bar	bar	bar	gr/mt	mm	m
9	12	7	28	-	-	120	50
11	15	7,5	30	-	-	250	50



Sottostrato
Inner layer
Couche intérieure
Schlaucheinlage
Capa interior

Copertura
Outer Cover
Couche extérieure
Außenschicht
Capa exterior



-20°C / +60°C
-4°F / +140°F



- **FOOD GRADE FDA 177.2600**
- **LIGHT AND FLEXIBLE**



IMPIEGO / USE / EMPLOI / EINSATZ / EMPLEO

Tubo idoneo alla mandata di liquidi alimentari conforme alla DIRETTIVA FDA Title 21 part 170 to 199 item 177.2600.

Suitable for the delivery of liquid foodstuffs according to DIRECTIVE FDA Title 21 part 170 to 199 item 177.2600.

Idéal pour refoulement des liquides alimentaires selon la DIRECTIVE FDA Title 21 part 170 to 199 item 177.2600.

Geeignet für die Lieferung von flüssigen Lebensmitteln, gemäß der RICHTLINIE FDA vom Titel 21 Teil 170 bis 199 Artikel 177.2600.

Idóneo para la entrega de líquidos alimenticios según DIRECTIVE FDA Title 21 part 170 to 199 item 177.2600.

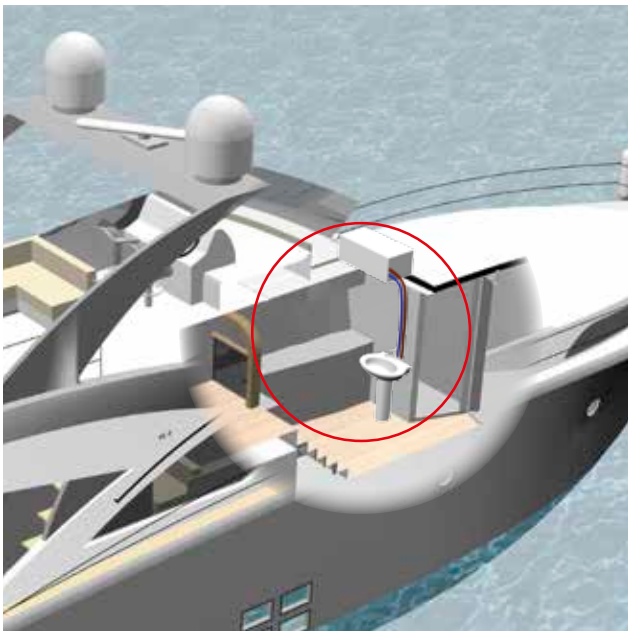

**STRUTTURA / STRUCTURE / STRUCTURE
STRUKTUR / ESTRUCTURA**

SOTTOSTRATO

INNER LAYER
COUCHE INTÉRIEURE
SCHLAUCHEINLAGE
CAPA INTERIOR

A

Liscio, nero, a base di gomma sintetica.

Smooth black EPDM rubber.

Lisse en caoutchouc EPDM noir.

Glatt, schwarz, aus synthetischem Gummi.

Caucho EPDM liso negro.

INSERTI

REINFORCEMENT
RENFORCEMENT
EINLAGEN
REFUERZOS

B

Tessili sintetici ad alta resistenza agli agenti atmosferici, di colore rosso o blu.

High tenacity textile synthetic yarns.

Gaines textiles synthétiques de haute ténacité.

Hochzugfeste synthetische Textilgarne.

Hilos textiles sintéticos de alta tenacidad.

COPERTURA

OUTER COVER
COUCHE EXTERIEURE
AUSSENSCHICHT
CAPA EXTERIOR

C

Liscia, in gomma EPDM, resistente alla temperatura, all'abrasione e agli agenti atmosferici.

Black, smooth, EPDM rubber antiabrasive, high temperature, and weathering resistant, in red or blue colour.

En EPDM, lisse, noir, antiabrasif, résistant à la haute température et aux agents atmosphériques, en couleur rouge ou bleue.

Schwarzer, glatter EPDM-Gummi in roter oder blauer Farbe. Abriebfest und Beständig gegen hohe Temperaturen und Witterung.

En EPDM, lisa, negra, antiabrasivo, resistente a temperaturas altas y a los agentes atmosféricos, en color rojo o azul.

IMBALLO: polietilene trasparente **PACKAGING:** transparent polyethylene
EMBALLAGE: polyéthylène transparent **VERPACKUNG:** transparentes Polyethylen
EMBALAJE: polietileno transparente

mm	mm	bar	bar	bar	g/m	mm	mt
13	20	15	45	-	0,225	130	100



Sottostrato
Inner layer
Couche intérieure
Schlaucheinlage
Capa interior



Inserti
Reinforcement
Renforcement
Einlagen
Refuerzos



Copertura
Outer Cover
Couche extérieure
Außenschicht
Capa exterior



-40°C / +120°C
-40°F / +257°F



- **VERY LIGHT**
- **EXTRA FLEXIBLE**



IMPIEGO / USE / EMPLOI / EINSATZ / EMPLEO









Idoneo per aspirazione e passaggio di aria, fumi, polveri, trucioli e filamenti. Utilizzato anche come guaina passacavi.

Suitable for industrial ventilation and ducting of air, fumes, dust, powders and wood-chips.

Idéal pour ventilation et aspiration d'air, des poussières, des fumées, des poudres et des copeaux de bois.

Geeignet für industrielle Belüftung und Kanalisierung von Luft, Dämpfen, Staub, Pulvern und Holzspänen.

Idóneo para ventilación y aspiración del aire, humos, polvos y varutas de madera.

 mm	 mm	 bar	 bar	 bar	 g/m	 mm	 mt
20	24,8	1	-	0,5	115	28	30
25	30	0,5	-	0,5	165	35	30
30	35,2	0,5	-	0,5	215	42	30
32	38	0,5	-	0,5	225	45	30
35	41	0,5	-	0,5	235	47	30
38	44,2	0,5	-	0,5	255	50	30
40	46,5	0,5	-	0,5	270	55	30
45	52,2	0,5	-	0,5	350	60	30
50	57	0	-	0,45	435	65	30
60	68	0	-	0,45	525	80	30
70	78,4	0	-	0,45	620	95	30
75	84	0	-	0,4	670	100	30
80	89	0	-	0,4	755	110	30
90	99	0	-	0,4	805	125	30
100	110	0	-	0,4	950	140	30
110	120,4	0	-	0,4	1065	150	30
120	131	0	-	0,35	1165	170	30
130	141	0	-	0,35	1210	175	30
140	151	0	-	0,35	1455	190	30
150	162	0	-	0,35	1650	200	30
160	172	0	-	0,3	1800	220	20
180	193	0	-	0,3	2130	250	20
200	214	0	-	0,3	2330	280	20
250	264	0	-	0,3	3240	300	10
300	316	0	-	0,3	3980	330	10



STRUTTURA / STRUCTURE / STRUCTURE STRUKTUR / ESTRUCTURA

COPERTURA

OUTER COVER
COUCHE EXTERIEURE
AUßENSCHICHT
CAPA EXTERIOR

Corrugata, resistente all'abrasione, agenti chimici ed atmosferici.

Corrugated outer cover resistant to crushing, chemical agents, abrasion and weathering condition.

Couche extérieure ondulée résistante à l'abrasion, à l'écrasement et aux agents atmosphériques.

Äusserst strapazierfähig und biegsam, druck- und abriebfest, witterungs- und chemikalienbeständig, gewellte Außendecke.

Externa ondulada resistente a cargas, abrasión y agentes atmosféricos.

SPIRALE

WIRE
SPIRALE
SPIRAL
ESPIRAL

Spirale in PVC rigida antiurto, parete corrugata in PVC flessibile, colore grigio.

Rigid PVC spiral shock resistant, flexible PVC corrugated wall, grey colour.

Spirale in PVC rigide antichoc, paroi ondulée en PVC flexible, couleur grise.

Harte PVC-Spirale, stoßfeste und flexible PVC-Wellwand, graue Farbe.

Espiral en PVC rigido antichoques, pared corrugada en PVC flexible, color gris.

IMBALLO: polietilene bianco **PACKAGING:** White polyethylene
EMBALLAGE: polyéthylène blanc **VERPACKUNG:** Weiß Polyethylen
EMBALAJE: polietileno blanco

NORME / NORMS / NORMES / NORMEN / NORMAS: ISO 1307



Copertura
Outer Cover
Couche extérieure
Außenschicht
Capa exterior



Spirale
Wire
Spirale
Spiral
Espiral



-5°C / +60°C
+23°F / +140°F



• **EXTREMELY FLEXIBLE AND LIGHT**



IMPIEGO / USE / EMPLOI / EINSATZ / EMPLEO

Tubazione estremamente flessibile e leggera, idonea per ventilazione meccanica, per collegamento bocchette e diffusori.

Extremely light and flexible hose for ventilation and air conditioning.

Tuyau extrêmement souple et léger, adapté pour la ventilation et systèmes de climatisation.

Extrem flexibler und leichter Schlauch, geeignet für die Klimatisierung und Durchlüftung.

Manguera muy flexible y ligera idónea para ventilación y sistemas de acondicionamiento.

mm	mm	bar	bar	bar	g/m	mm	mt
51	-	-	-	-	-	0,6 x Di	10
63	-	-	-	-	-	0,6 x Di	10
70	-	-	-	-	-	0,6 x Di	10
76	-	-	-	-	-	0,6 x Di	10
80	-	-	-	-	-	0,6 x Di	10
89	-	-	-	-	-	0,6 x Di	10
102	-	-	-	-	-	0,6 x Di	10
110	-	-	-	-	-	0,6 x Di	10
121	-	-	-	-	-	0,6 x Di	10
127	-	-	-	-	-	0,6 x Di	10
133	-	-	-	-	-	0,6 x Di	10
140	-	-	-	-	-	0,6 x Di	10
152	-	-	-	-	-	0,6 x Di	10
160	-	-	-	-	-	0,6 x Di	10
180	-	-	-	-	-	0,6 x Di	10
203	-	-	-	-	-	0,6 x Di	10
254	-	-	-	-	-	0,6 x Di	10
305	-	-	-	-	-	0,6 x Di	10
356	-	-	-	-	-	0,6 x Di	10
406	-	-	-	-	-	0,6 x Di	10
457	-	-	-	-	-	0,6 x Di	10



**STRUTTURA / STRUCTURE / STRUCTURE
STRUKTUR / ESTRUCTURA**

COPERTURA

OUTER COVER
COUCHE EXTERIEURE
AUSSENSCHICHT
CAPA EXTERIOR

Copertura corrugata.
Corrugated outer cover
Couche extérieure ondulée.
Gewellte Außendecke.
Capa exterior corrugada.



SPIRALE

WIRE
SPIRALE
SPIRAL
ESPIRAL



Tessuto poliestere spalmato di resine poliolefiniche addittivate, spirale elicoidale in filo di acciaio armonico, superficie corrugata in colore grigio metallico.
Polyester fabric coated with added polyolefin resins, helicoidal spiral in harmonic steel wire, corrugated surface in gray metallic colour.
Tissu en poliestère enduit par couverture en résines de poliolefinas, spirale hélicoidale en fil d'acier harmonique, paroi ondulée de couleur grise métallique.
Mit zugesetzten Polyolefinharzen und beschichtetem Polyestergewebe, Spirale aus harmonischem Stahldraht, gewellte Oberfläche in grauer Metall-Farbe.
Tejido en poliéster con cobertura en resinas de poliolefinas. Espiral helicoidal en hilo de acero harmónico, pared corrugada en color gris metálico.

Comprimità assiale / Axial compressibility / Compressibilité axiale /
Axiale Komprimierbarkeit / Compresibilidad axial: 8 : 1

REAZIONE AL FUOCO CLASSE 1 / BEHAVIOUR TO FIRE CLASSE 1 / COMPORTEMENT AU FEU CLASSE 1 / BRANDVERHALTEN CLASSE 1 / COMPORTAMIENTO AL FUEGO CLASSE 1

NORME UNI / UNI NORMS / NORMES UNI / UNI NORMEN / NORMAS UNI:
84 56/87 + UNI 9174/87 + UNI 9174/A1/96



Copertura
Outer Cover
Couche extérieure
Außenschicht
Capa exterior



Spirale
Wire
Spirale
Spiral
Espiral

-20°C / +90°C
con picchi fino a
with peaks up to +110°C
-4°F / +194°F
con picchi fino a
with peaks up to +212°F



- **COMPRESSIBILITY 8:1**
- **VERY FLEXIBLE AND LIGHT**



IMPIEGO / USE / EMPLOI / EINSATZ / EMPLEO

Idoneo per passaggio di aria, fumi e polveri; eccellente resistenza alle alte e basse temperature, eccellente flessibilità; particolarmente indicato nel condizionamento navale e civile.

Suitable for air, fume & dust ducting, for heating and ventilation systems; excellent resistance to high and low temperatures, excellent flexibility; particularly recommended for civil and naval air conditioning systems.

Idéal pour le passage d'air, des fumées et poussières; excellente résistance aux hautes et basses températures, excellente flexibilité; particulièrement recommandé pour systèmes de ventilation d'air aux secteurs civil et naval.

Geeignet für Luft-, Rauch- und Staubkanäle, für Heizungs- und Lüftungssysteme. Ausgezeichnete Beständigkeit gegen hohe und niedrige Temperaturen, ebenso ausgezeichnete Flexibilität. Besonders empfehlenswert für zivile und Marine-Klimaanlagen.

Manguera idónea para paso del aire, humos y polvos; excelente resistencia a temperaturas altas y bajas; excelente flexibilidad; particularmente recomendada para el acondicionamiento de aire en los sectores civil y naval.

mm	mm	bar	bar	bar	g/m	mm	mt
40	-	-	0,90	0,24	120	0,7xDi	10
45	-	-	0,80	0,20	130	0,7xDi	10
50	-	-	0,80	0,20	145	0,7xDi	10
60	-	-	0,80	0,16	170	0,7xDi	10
65	-	-	0,70	0,14	182	0,7xDi	10
70	-	-	0,70	0,14	198	0,7xDi	10
76	-	-	0,60	0,10	210	0,7xDi	10
80	-	-	0,60	0,10	227	0,7xDi	10
90	-	-	0,50	0,09	254	0,7xDi	10
100	-	-	0,50	0,09	285	0,7xDi	10
110	-	-	0,50	0,08	310	0,7xDi	10
120	-	-	0,50	0,08	342	0,7xDi	10
125	-	-	0,40	0,08	356	0,7xDi	10
130	-	-	0,40	0,08	370	0,7xDi	10
140	-	-	0,25	0,06	398	0,7xDi	10
150	-	-	0,25	0,06	427	0,7xDi	10
160	-	-	0,20	0,06	527	0,7xDi	10
180	-	-	0,20	0,06	590	0,7xDi	10
200	-	-	0,20	0,05	660	0,7xDi	10
250	-	-	0,10	0,04	825	0,7xDi	10
300	-	-	0,06	0,03	990	0,7xDi	10
350	-	-	0,05	0,02	1155	0,7xDi	10
400	-	-	0,04	0,01	1320	0,7xDi	10



STRUTTURA / STRUCTURE / STRUCTURE STRUKTUR / ESTRUCTURA

COPERTURA

OUTER COVER
COUCHE EXTERIEURE
AUSSENSCHICHT
CAPA EXTERIOR

Copertura corrugata.
Corrugated outer cover
Couche extérieure ondulée.
Gewellte Außendecke.
Capa exterior corrugada.

C

SPIRALE

WIRE
SPIRALE
SPIRAL
ESPIRAL

B

Tessuto in poliamide spalmato di PVC sui due lati, spirale in acciaio elicoidale incorporata in filo armonico. Superficie corrugata in colore grigio scuro metallico.
Polyamide fabric, PVC coated on both sides, harmonic wire embedded helicoidal steel spiral. Corrugated surface in dark gray metallic colour.
Tissu en polyamide, revêtu de PVC double face, spirale en acier hélicoïdale incorporée en fil harmonique. Surface ondulée de couleur gris foncée métallique.
Polyamidgewebe, beidseitig PVC-beschichtet, mit harmonischem Draht und eingebetteter Stahlschpirale. Gewellte Oberfläche in dunkelgrauer Metall-Farbe.
Tejido en poliamida, cubierto con PVC de ambos lados, espiral en acero helicoidal incorporada en hilo armónico. Superficie corrugada en color gris oscuro metálico.

Comprimità assiale / Axial compressibility / Compressibilité axiale /

Axiale Komprimierbarkeit / Compressibilidad axial: 8 : 1

REAZIONE AL FUOCO CLASSE 1 / BEHAVIOUR TO FIRE CLASSE 1 / COMPORTEMENT AU FEU CLASSE 1 / BRANDVERHALTEN CLASSE 1 / COMPORTAMIENTO AL FUEGO CLASSE 1

NORME UNI / UNI NORMS / NORMES UNI / UNI NORMEN / NORMAS UNI:

84 56/87 + UNI 9174/87 + UNI 9174/A1/96



Copertura
Outer Cover
Couche extérieure
Außenschicht
Capa exterior



Spirale
Wire
Spirale
Spiral
Espiral

-20°C / +90°C
con picchi fino a
with peaks up to +130°C
-4°F / +194°F
con picchi fino a
with peaks up to +266°F

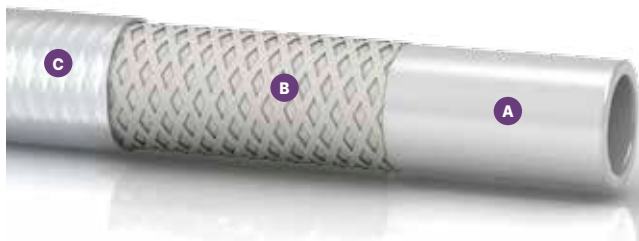

- NO TWIST VERSION
- ROBUST STRUCTURE



IMPIEGO / USE / EMPLOI / EINSATZ / EMPLEO

Idoneo per mandata di acqua in pressione utilizzato per la pulizia dei ponti sulle imbarcazioni da diporto, molto maneggevole, flessibile e antitorsione.

Suitable for water delivery in general and leisure boat deck washing. Light, flexible and no-twist hose.

Convenable pour le refoulement d'eau en general et le lavage des ponts sur les bateaux de plaisance. Très léger, souple, anti-vrille.

Geeignet für die Wasserversorgung im Allgemeinen und für die Deckreinigung von Freizeitbooten. Leichter, flexibler und verdrehungsfreier Schlauch.

Idóneo para le descarga de agua en general y lavaje de los puentes de embarcaciones de recreo. Lijero, flexible y anti-torsión.



STRUTTURA / STRUCTURE / STRUCTURE STRUKTUR / ESTRUCTURA

SOTTOSTRATO

INNER LAYER
COUCHE INTÉRIEURE
SCHLAUCHEINLAGE
CAPA INTERIOR

A

PVC colore bianco.
White colour PVC.
PVC couleur blanche
Weißes PVC.
PVC color blanco.

INSERTI

REINFORCEMENT
EINLAGEN
REFUERZOS

B

Tessili sintetici.
Textile synthetic yarns.
Gaines textiles synthétiques.
Synthetische Textilgarne.
Hilos textiles sintéticos.

COPERTURA

OUTER COVER
COUCHE EXTERIEURE
AUSSENSCHICHT
CAPA EXTERIOR

C

PVC di colore bianco con banda azzurra.
White colour PVC with blue ribbon.
PVC couleur blanche à bande bleue.
Weißes PVC mit blauem Band.
PVC color blanco con banda azul.

IMBALLO: polietilene trasparente PACKAGING: transparent polyethylene

EMBALLAGE: polyéthylène transparent VERPACKUNG: transparentes Polyethylen

EMBALAJE: polietileno transparente

 mm	 mm	 bar	 bar*	 bar*	 g/m	 mm	 mt
10	2,5	10	30	-	110	-	25/50
13	2,8	10	32	-	170	-	25/50
16	2,8	10	32	-	200	-	25/50
19	3	10	32	-	260	-	25/50
22	3	10	21	-	300	-	25/50
25	3,5	10	32	-	420	-	25/50
30	4	5	15	-	529	-	25/50

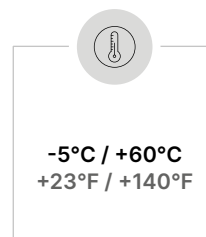
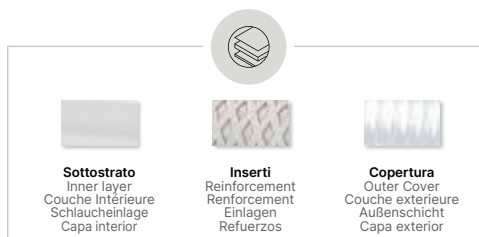

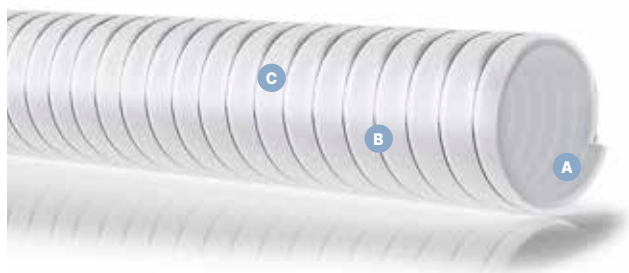

- **VERY FLEXIBLE**
- **LOW NOISE**
- **ANTIBACTERIAL**



IMPIEGO / USE / EMPLOI / EINSATZ / EMPLEO

Utilizzato nel condizionamento dell'aria, ventilazione meccanica semplice e a doppio flusso, riduzione della condensa e delle dispersioni di calore, impianti di condizionamento dell'aria per mezzi di trasporto, per uso agricolo, industriale e navale.

Air conditioning, mechanical ventilation simple or double flow, reduction of condensation and heat dispersion, air conditioning systems for transport vehicles in the agricultural, industrial and marine sectors.

Utilisé pour la climatisation, ventilation mécanique simple et à double flux, réduction de la condensation et des dispersions de chaleur, systèmes de climatisation pour les véhicules, secteur agricole, industriel et navale.

Geeignet für Klimaanlage, mechanische Belüftungen mit Einfachoder Doppelstrom, für die Reduzierung von Kondensation und Wärmeausbreitung. Wird vor allem in der Landwirtschaft, in der Industrie und im Marinebereich verwendet.

Utilización en climatización, ventilación mecánica de simple y doble flujo, reducción de condensaciones y dispersión de calor, sistemas de climatización para medios de transporte, para uso agrícola, industrial y naval.

mm	mm	bar	bar*	bar*	g/m	mm	mt
51	-	0,70	-	0,18	96	35	10
63	-	0,70	-	0,15	115	42	10
70	-	0,60	-	0,13	128	49	10
80	-	0,50	-	0,09	154	56	10
102	-	0,40	-	0,08	200	70	10
127	-	0,40	-	0,07	254	92	10
152	-	0,20	-	0,05	308	105	10
160	-	0,15	-	0,05	331	110	10
180	-	0,15	-	0,05	438	130	10
203	-	0,15	-	0,04	492	140	10
254	-	0,08	-	0,03	600	175	10

*Dati di pressione e vuoto basati sulla temperatura ambiente +20°C.
*Pressure and vacuum data based on +20°C room temperature.



STRUTTURA / STRUCTURE / STRUCTURE
AUFBAU / ESTRUCTURA

SOTTOSTRATO INNER LAYER COUCHE INTÉRIEURE SCHLAUCHEINLAGE CAPA INTERIOR	INSERTI REINFORCEMENT REINFORCEMENT EINLAGEN REFUERZOS	COPERTURA OUTER COVER COUCHE EXTERIEURE AUßENSCHICHT CAPA EXTERIOR
Resine poliolefiniche additivate. Polyolefin resin film with additives. Film en résines de polyoléfines avec aditifs. Película en resinas poliolefinicas con aditivos.	Spirale in filo di acciaio armonico. Harmonic steel wire helix. Hélice harmonique en fil d'acier. Harmonische Stahlspirale. Hélice harmónica en hilo de acero.	Rivestimento termoisolante in polietilene reticolato ed espanso a celle chiuse. Protezione esterna: film di resine poliolefiniche additivate. Thermo-insulating cover in netted and closes cell foam polyethylene. Outer protection: insulation in polyolefin resins. Revêtement thermo-isolant au polyéthylène réticulé et de la mousse à cellules fermées. Protección externa: aislante en resinas poliolefinicas. Wärmeisolierende Abdeckung aus netzartigem und geschlossenzelligem Polyethylenschäum. Äußere: Schutzisolierung aus Polyolefinharzen. Recubrimiento termo-aislante en polietileno reticulado y espuma de celda cerrada. Protección externa: aislante en resinas poliolefinicas.

NETTED POLYETHYLENE FOAM TYPE CL1

PHYSICAL AND MECHANICAL PROPERTIES	S.M.	RULES	VALUE
Coefficient of thermal conductivity at 0°C (λ)	W/mk	UNI EN 12664:2002	0,032
Coefficient of thermal conductivity at 10°C (λ)	W/mk	UNI EN 12664:2002	0,033
Coefficient of thermal conductivity at 30°C (λ)	W/mk	UNI EN 12664:2002	0,035
Coefficient of thermal conductivity at 60°C (λ)	W/mk	UNI EN 12664:2002	0,038
Chemical Agent Attack		Application of specifical agents and control after 48 hours	Ethanol, Ammonia, liquid refrigerant, no damage
Channel Sealing		EN 12237 EN 1507 EN 12599	Classe D
Channel Sealing		EN 13108	Conforme

REAZIONE AL FUOCO CLASSE 1 / BEHAVIOUR TO FIRE CLASSE 1 / COMPOTEMENT AU FEU CLASSE 1 / BRANDVERHALTEN CLASSE 1 / COMPORTAMIENTO AL FUEGO CLASSE 1

Sottostrato
Inner layer
Couche Intérieure
Schlaucheinlage
Capa interior

Inserti
Reinforcement
Reinforcement
Einlagen
Refuerzos

Copertura
Outer Cover
Couche extérieure
Außenschicht
Capa exterior

-20°C / +90°C
con picchi fino a
with peaks up to +115°C
(Max 2 min)
-4°F / +194°F
con picchi fino a
with peaks up to +239°F
(Max 2 min)

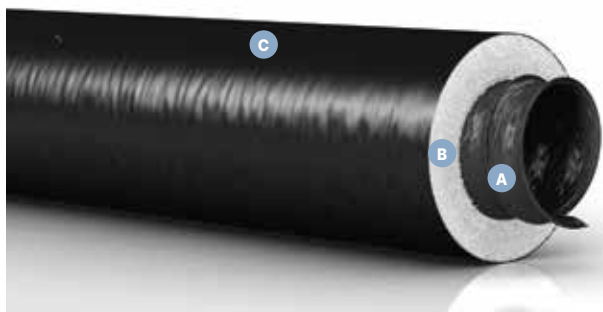

• **VERY FLEXIBLE**



IMPIEGO / USE / EMPLOI / EINSATZ / EMPLEO

Ventilazione meccanica a semplice e doppio flusso. Riduzione della condensa e delle dispersioni di calore. Utilizzato per condizionamento dell'aria. Indicato nel settore industriale e navale.

Suitable for single and double flow mechanical ventilation, for the reduction of water condensates and heat dispersion also for air conditioning. Recommended for use in the Industrial and naval construction sectors.

Tuyau utilisé pour ventilation simple et double flux. Adapté pour la réduction de la buée et des dispersions de chaleur. Utilisé pour conditionnement de l'air. Recommandé pour les secteurs civil et naval.

Geeignet für einfache- und doppelströmige mechanische Belüftungen. Reduzierung von Kondensation und Wärmedispersion. Geeignet für Klimaanlage. Es wird in der Marine und in den industriellen Sektoren verwendet.

Manguera idónea para la ventilación a flujo simple y doble, para la reducción del agua de condensación y dispersión de calor, también utilizada para el acondicionamiento del aire. Recomendada para los sectores industrial y de construcción naval.

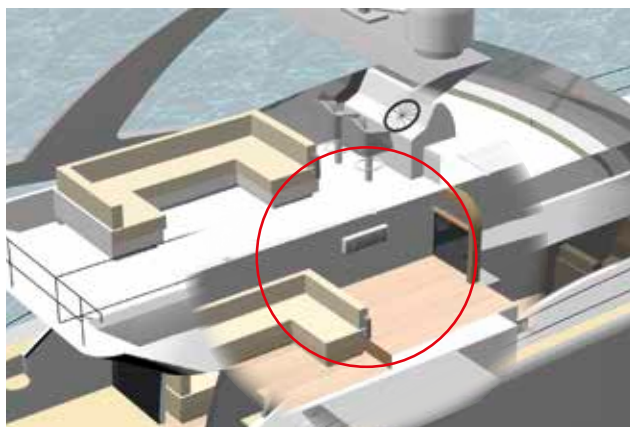

ESEMPI DI CALCOLO DELLE PORTATE E DELLE PERDITE DI CARICO:
EXAMPLE OF CALCULATION OF FLOW RATES AND PRESSURE DROP:

Ø	AIR SPEED 8 mt/sec.		AIR SPEED 10 mt/sec.		mt
	AIR FLOW m³/h	LOAD LOSS in Pa	AIR FLOW m³/h	LOAD LOSS in Pa	
80	152	1	190	31	10
102	250	15	333	24	10
127	383	12	368	18	10
160	575	8	773	14	10
203	900	6,5	1151	10,5	10
254	1445	4,7	1843	7,5	10
318	2278	3,7	3105	6	10
356	3058	3	3850	5,2	10
406	3845	2,7	4590	4,4	10
508	5111	2	8223	3	10

Per calcolare le portate e le perdite di carico degli altri diametri richiedere il nostro diagramma delle perdite di carico.

To calculate the flow and pressure drop of the other diameter, request our pressure drop diagram.



**STRUTTURA / STRUCTURE / STRUCTURE
AUFBAU / ESTRUCTURA**

SOTTOSTRATO

INNER LAYER
COUCHE INTÉRIEURE
SCHLAUCHEINLAGE
CAPA INTERIOR

A

Resine poliolefiniche additivate.
Polyolefin resin film with additives.
Film en résines polyoléfiniques avec additifs.
Polyolefinharzfolie mit Zusatzstoffen.
Película en resinas poliolefinicas con aditivos.

INSERTI

REINFORCEMENT
REINFORCEMENT
EINLAGEN
REFUERZOS

B

Harmonic steel wire helix.
Hélice harmonique en fil d'acier.
Harmonische Stahldrahtspirale.
Hélice harmónica en hilo de acero.

COPERTURA

OUTER COVER
COUCHE EXTERIEURE
AUSSENSCHICHT
CAPA EXTERIOR

C

Rivestimento termoisolante in fibra di poliestere (sp.25mm/16Kg/m³). Protezione esterna antivapore in resina poliolefinica additivata.
Thermo-insulating cover in polyester fiber (thickness 25mm/16Kg/m³). Outer anti-steam protection in polyolefin resins with additives.
Revêtement thermo-isolant en fibre de polyester (épaisseur 25mm/16Kg/m³). Protection anti-vapeur extérieure en résines polyoléfiniques avec additifs.
Wärmeisolierende Abdeckung aus Polyesterfasern (Stärke 25mm/16kg/m³). Äußerer Dampfschutz aus Polyolefinharzen mit Zusatzstoffen.
Recubrimiento termo-aislante en fibra de poliéster (espesor 25mm/16Kg/m³). Protección anti-vapor externa por resinas poliolefinicas con aditivos.

REAZIONE AL FUOCO CLASSE 1 / BEHAVIOUR TO FIRE CLASSE 1 / COMPORTEMENT AU FEU CLASSE 1 / BRANDVERHALTEN CLASSE 1 / COMPORTAMIENTO AL FUEGO CLASSE 1



Sottostrato
Inner layer
Couche intérieure
Schlaucheinlage
Capa interior



Inserti
Reinforcement
Reinforcement
Einlagen
Refuerzos



Copertura
Outer Cover
Couche extérieure
Außenschicht
Capa exterior



-20°C / +90°C
con picchi fino a
with peaks up to +110°C
+22°F / +212°F
con picchi fino a
with peaks up to +230°F

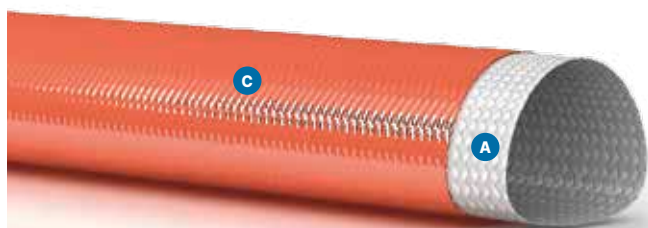

• **HEAT RESISTANT**



IMPIEGO / USE / EMPLOI / EINSATZ / EMPLEO

Utilizzata per isolare i tracciatori di linee a vapore nelle raffinerie di olio, come isolante termico ed elettrico per l'industria di cavi e fili, nelle creazioni in vetro, per le coperture delle estremità rifinite in metallo, fonderie e acciaierie e qualunque altra applicazione dove è richiesta una barriera protettiva per l'alta temperatura.

It is used to insulate steam tracer lines in oil refineries, as thermal and electrical insulation for the wire and cable industry, in glass manufacturing, for covering tines in metal refining, foundries and steel mills, and wherever else a high temperature barrier might be required.

Il est utilisé pour isoler les lignes de traçage à la vapeur dans les raffineries de pétrole, comme isolant thermique et électrique pour les industries du fil et du câble, dans la fabrication du verre, pour couvrir les dents des raffineries de métaux, des fonderies et des aciéries, ainsi que partout ailleurs être requis.

Es wird verwendet, um Dampf-Tracer-Linien in Ölraffinerien, als thermische und elektrische Isolierung für die Draht- und Kabelindustrie, in der Glasherstellung, zur Abdeckung von Zinken in Metallraffinerien, Gießereien und Stahlwerken und wo auch immer eine Hochtemperaturbarriere zu isolieren erforderlich sein.

Se utiliza para aislar líneas de trazador de vapor en refinarias de petróleo, como aislamiento térmico y eléctrico para la industria de alambres y cables, en la fabricación de vidrio, para cubrir dientes en refinación de metales, fundiciones y acerías, y en cualquier otro lugar donde una barrera de alta temperatura pueda ser requerida.

mm	FIBERGLASS mm	SILICON mm	g/m	mt
10	2,5	1,0	-	20
12	2,5	1,0	-	20
15	2,5	1,0	-	20
20	2,5	1,0	-	20
25	2,5	1,0	-	20
30	2,5	1,0	-	20
35	2,5	1,0	-	20
38	2,5	1,0	-	20
40	2,5	1,0	-	20
42,5	2,5	1,0	-	20
45	2,5	1,0	-	15
50	2,5	1,0	-	15
60	2,5	1,0	-	15
65	2,5	1,0	-	15
70	2,5	1,0	-	15
75	2,5	1,0	-	15
80	2,5	1,0	-	15
85	2,5	1,0	-	15
90	2,5	1,0	-	15
100	2,5	1,0	-	15
115	2,5	1,0	-	15
125	2,5	1,0	-	15



STRUTTURA / STRUCTURE / STRUCTURE STRUKTUR / ESTRUCTURA

SOTTOSTRATO

INNER LAYER
COUCHE INTÉRIEURE
SCHLAUCHEINLAGE
CAPA INTERIOR

Calza in fibra di vetro con silicone è costituita da fili di fibra di vetro "E".

Protech/SIL is a braided sleeving which is manufactured from E-fiberglass yarn.

Protech / SIL est une gaine tressée fabriquée à partir de fil de fibre de verre E.

Protech / SIL ist ein geflochtener Schlauch, der aus E-Fiberglasgarn hergestellt wird.

Protech / SIL es una funda trenzada que se fabrica a partir de hilados de fibra de vidrio.

A

COPERTURA

OUTER COVER
COUCHE EXTERIEURE
AUSSENSCHICHT
CAPA EXTERIOR

Silicone
Superficie: esterna lucida, colore rosso.

Silicon
Outer layer: smooth, red colour.

Silicone
Couche extérieure: lisse, couleur rouge.

Silikon
Oberfläche: glatt, rote Farbe.

Silicona
Capa exterior: lisa, color rojo.

C

NORME / NORMS / NORMES / NORMEN / NORMAS:

R.I.N.A approved according to ISO 15540:199(E) and ISO 15541-199 (E) - UL 1441 VW-1

BRIEF DETAILS

Fiberglass filament	Tipo "E"
Fiberglass diameter	9 Micron
Fire resistance	Self-extinguishes
Rip resistance	19 KN/m
Tensile strength	10.0 Mpa
Continuous operating temperature	260%
Dielectric Strength	26 KV/mm
Density at 23°C	1,16 g/cm ²



Sottostrato
Inner layer
Couche intérieure
Schlaucheinlage
Capa interior



Copertura
Outer Cover
Couche extérieure
Außenschicht
Capa exterior



+260°C
+500°F



- EXTRA LIGHT
- EXTRA FLEXIBLE



IMPIEGO / USE / EMPLOI / EINSATZ / EMPLEO





È normalmente utilizzato come guaina di protezione di altre tubazioni. Viene anche utilizzato per passaggio di aria nel settore automobilistico.

Used as protective conduit for other hoses and for air conveyance in the automotive sector.

Utilisé comme gaine de protection d'autres tuyaux ou pour le passage d'air dans le secteur automobile.

Wird als Schutzschlauch für andere Schläuche und zur Luftdurchführung im Automobilbereich eingesetzt.

Para protección de otras mangueras y para suministros de aire en el sector automovil.

 mm	 mm	 g/m	 mm	 mt
10,4*	13,4	22	13	50
11,4*	15,1	25	15	50
14,4*	18,1	35	18	50
17*	21,2	40	21	50
20	24,5	50	24	50
26,5	30,5	69	30	50
28	32,2	74	32	50
30,5	35	85	35	50
35*	40,5	100	40	50
40,5	47,5	110	47	50
50,5	57,8	175	57	50
61	68	225	68	50
70	78	265	78	50
80	89,5	310	89	25
90,5	99,5	350	99	25
100	110,5	410	110	25
120	129	515	129	25
140	155	650	155	25

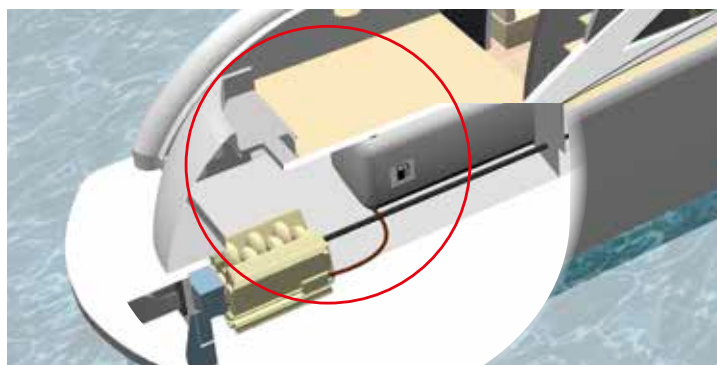

STRUTTURA / STRUCTURE / STRUCTURE AUFBAU / ESTRUCTURA

Tubo in polipropilene, superficie corrugata.

Polypropylene hose, corrugated surface.

Tuyau en polypropylène, surface ondulée.

Polypropylenschlauch, gewellte Oberfläche.

Manguera en polipropileno, superficie corrugada.

NORME / NORMS / NORMES / NORMEN / NORMAS: ISO 1307



Copertura
Outer Cover
Couche extérieure
Außenschicht
Capa exterior



-5°C / +100°C
+23°F / +212°F

* Diametri producibili su richiesta / Available on request /
Diamètres disponibles sur demande / Durchmesser auf Anfrage erhältlich /
Diámetros disponible previa solicitud

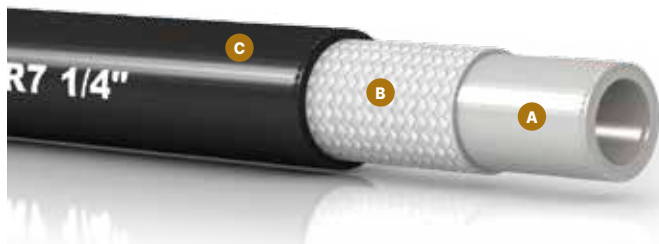

- **EXTRA FLEXIBLE**
- **AGEING RESISTANT**



IMPIEGO / USE / EMPLOI / EINSATZ / EMPLEO

Tubo flessibile per alta pressione termoplastico per applicazioni oleodinamiche, particolarmente indicato nel settore nautico. **Certificato secondo EN855:1996 - R7; ISO3949:2004 / R7-1; SAE J517 FEB 98 100 R7.**

High pressure thermoplastic hose for oleodynamic, especially for the nautical sector. **According to EN855:1996 - R7; ISO3949:2004 / R7-1; SAE J517 FEB 98 100 R7.**

Tuyau flexible thermoplastique de haute pression pour applications oléodynamiques, particulièrement recommandé dans le secteur nautique. **Conforme à EN855:1996 - R7; ISO3949:2004 / R7-1; SAE J517 FEB 98 100 R7.**

Flexibler Hochdruckschlauch für thermoplastische Hydraulikanwendungen, besonders geeignet für die Schifffahrtsindustrie. **Zertifiziert gemäß EN855:1996 - R7; ISO3949:2004 / R7-1; SAE J517 FEB 98 100 R7.**

Manguera termoplástica de alta presión para aplicaciones oleodinámicas. Particularmente recomendada para el sector naval. **Cumple con EN855:1996 - R7; ISO3949:2004 / R7-1; SAE J517 FEB 98 100 R7.**



STRUTTURA / STRUCTURE / STRUCTURE STRUKTUR / ESTRUCTURA

SOTTOSTRATO

INNER LAYER
COUCHE INTÉRIEURE
SCHLAUCHEINLAGE
CAPA INTERIOR

Poliamide resistente ai solventi, vernici ed oli idraulici.

Polyamide resistant to solvents, paints and hydraulic oils.

Polyamide resistant aux solvants, peintures et huiles hydrauliques.

Polyamid, beständig gegen Lösungsmittel, Farben und Hydrauliköle.

Poliamida resistente a los solventes, pinturas y aceites hidráulicos.

INSERTI

REINFORCEMENT
RENFORCEMENT
EINLAGEN
REFUERZOS

2 trecce in fibre sintetiche ad alta resistenza.

High tenacity double braided polyester yarns.

Double tresse des gaines en polyestère de haute ténacité.

Hochzugfeste, doppelt geflochtene Polyestergarne.

Doble trenza en hilos de poliéster de alta tenacidad.

COPERTURA

OUTER COVER
COUCHE EXTERIEURE
AUSSENSCHICHT
CAPA EXTERIOR

In poliuretano antiabrasione, resistente all'olio e agli agenti atmosferici.

Anti-abrasive, oil and weathering resistant polyurethane.

En polyurethane antiabrasif, résistant aux huiles et agents atmosphériques.

Abriebfestes, öl- und witterungsbeständiges Polyurethan.

En poliuretano antiabrasivo, resistente a los lubricantes y agentes atmosféricos.

mm	mm	bar	bar*	bar*	g/m	mm	mt
5	3/16"	9,3	220	880	60	26	10/80
6,6	1/4"	12,5	215	860	100	30	10/80
8	5/16"	14,3	195	780	140	40	10/80
9,7	3/8"	16,5	187	750	170	70	10/80
13	1/2"	20,5	157	630	230	90	10/80

NORME / NORMS / NORMES / NORMEN / NORMAS:
EN 855:1996 R7, ISO 3949:2004/R7-1, SAE J517 FEB98 100R7



Sottostrato
Inner layer
Couche intérieure
Schlaucheinlage
Capa interior



Inserti
Reinforcement
Renforcement
Einlagen
Refuerzos



Copertura
Outer Cover
Couche extérieure
Außenschicht
Capa exterior



-40°C / +100°C
-40°F / +212°F

SATIBLOCK®

FASCETTE E COLLARI
STRINGITUBO

CLAMPS AND COLLARS

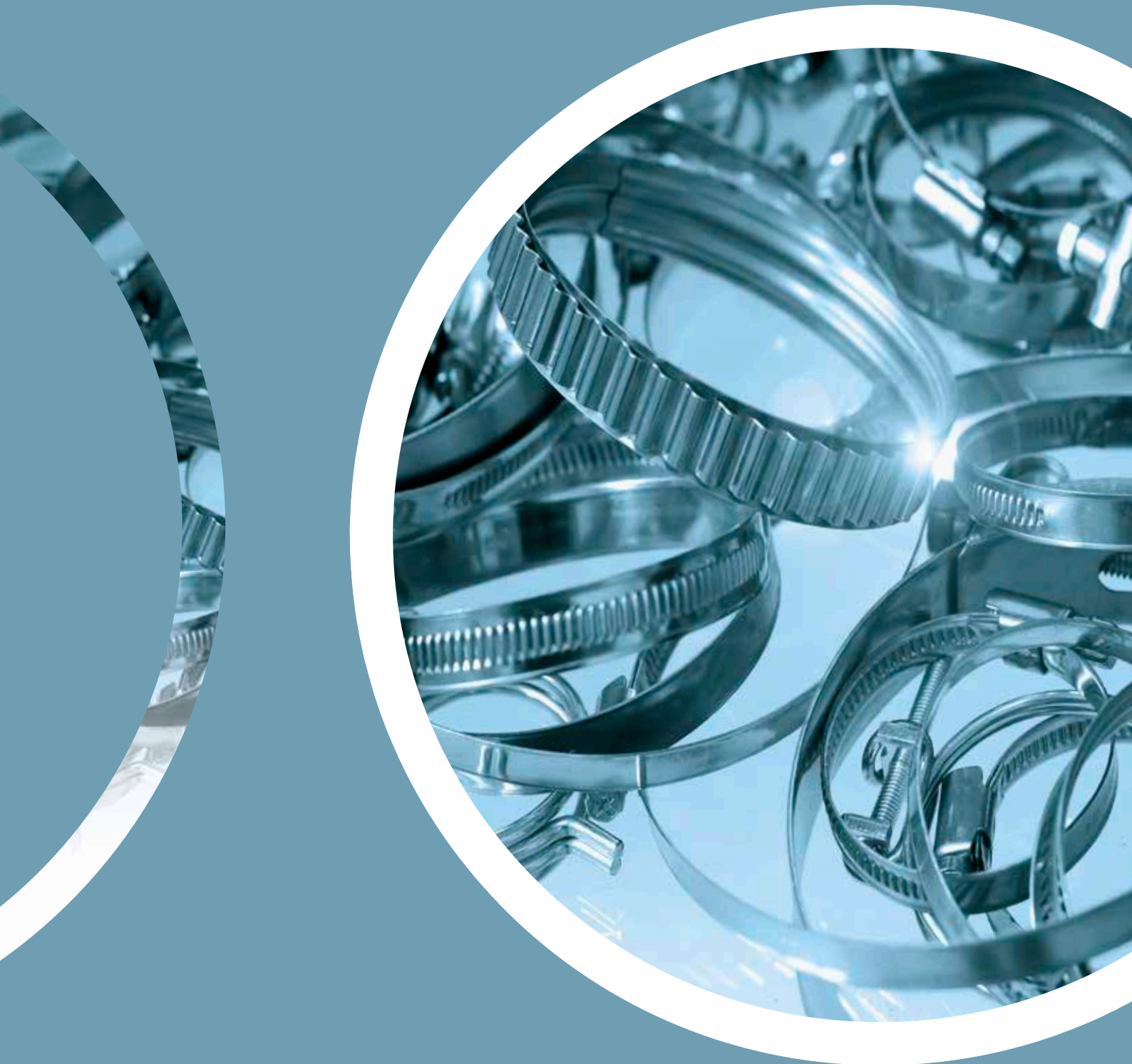

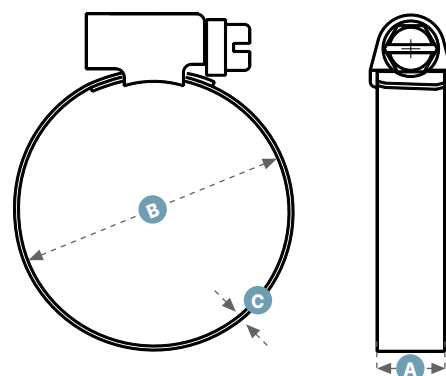

IMPIEGO APPLICATIONS

Industria in genere	Industry in general
Macchine agricole	Agriculture machine
Edilizia	Construction
Irrigazione	Irrigation



DESCRIZIONE DESCRIPTION

Fascetta ad altissima tenuta, compatta e resistente. La banda interna liscia ed i bordi rialzati, conferiscono assoluta sicurezza al tubo. Conforme alla normativa DIN 3017.

High resistant clamp, compact and durable. Rolle-up band edges and smooth band underside are able to guarantee total protection to the hose. According to DIN 3017.



MATERIALE MATERIAL

Banda Band	Acciaio inossidabile Stainless steel AISI 201
Cassetto Housing	Acciaio zincato Zinc-plated steel
Vite Screw	Acciaio zincato Zinc-plated steel

LARG. NASTRO BAND WIDTH	DIAM. DIAM.	SPESSORE THICKNESS	COPPIA DI SERRAGGIO RACCOMANDATA RECOMMENDED TIGHTENING TORQUE	SCATOLE BOX
A	B	C	Nm	pz/nrm
mm	mm	mm		

9 mm

W1A09008012000	9	8-12	0,8	2,6	100
W1A09010016000	9	10-16	0,8	2,6	100
W1A09012020000	9	12-20	0,8	2,6	100
W1A09016025000	9	16-25	0,8	4,0	100
W1A09016027000	9	16-27	0,8	4,0	100
W1A09020032000	9	20-32	0,8	4,0	100
W1A09025040000	9	25-40	0,8	4,0	100
W1A09035050000	9	32-50	0,8	4,0	50
W1A09040060000	9	40-60	0,8	4,0	50
W1A09050070000	9	50-70	0,8	4,0	50
W1A09060080000	9	60-80	0,8	4,0	50
W1A09070090000	9	70-90	0,8	4,0	25
W1A09080100000	9	80-100	0,8	4,0	25
W1A09090110000	9	90-110	0,8	4,0	25
W1A09100120000	9	100-120	0,8	4,0	25
W1A09110130000	9	110-130	0,8	4,0	25
W1A09120140000	9	120-140	0,8	4,0	25
W1A09130150000	9	130-150	0,8	4,0	25

12 mm

W1B12016025000	12	16-25	1,0	6,5	100
W1B12016027000	12	16-27	1,0	6,5	100
W1B12020032000	12	20-32	1,0	6,5	100
W1B12025040000	12	25-40	1,0	6,5	100
W1B12035050000	12	32-50	1,0	6,5	50
W1B12040060000	12	40-60	1,0	6,5	50
W1B12050070000	12	50-70	1,0	6,5	50
W1B12060080000	12	60-80	1,0	6,5	50
W1B12070090000	12	70-90	1,0	6,5	25
W1B12080100000	12	80-100	1,0	6,5	25
W1B12090110000	12	90-110	1,0	6,5	25
W1B12100120000	12	100-120	1,0	6,5	25
W1B12110130000	12	110-130	1,0	6,5	25
W1B12120140000	12	120-140	1,0	6,5	25
W1B12130150000	12	130-150	1,0	6,5	25
W1B12140160000	12	140-160	1,0	6,5	25
W1B12150170000	12	150-170	1,0	6,5	25
W1B12160180000	12	160-180	1,0	6,5	25
W1B12170190000	12	170-190	1,0	6,5	25
W1B12180200000	12	180-200	1,0	6,5	25

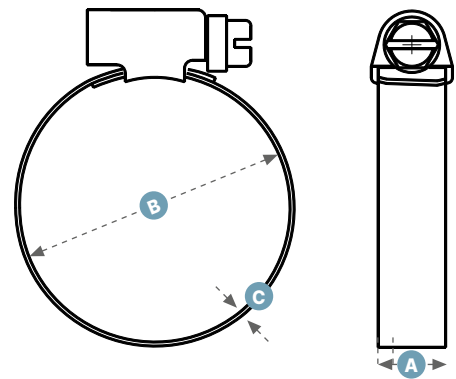

IMPIEGO APPLICATIONS

Macchine agricole	Agriculture machine
Edilizia	Construction
Irrigazione	Irrigation
Automotive	Automotive

DESCRIZIONE DESCRIPTION

Fascetta ad altissima tenuta, compatta e resistente. La banda interna liscia ed i bordi rialzati, conferiscono assoluta sicurezza al tubo. Conforme alla normativa DIN 3017.

High resistant clamp, compact and durable. Rolle-up band edges and smooth band underside are able to guarantee total protection to the hose. According to DIN 3017.

MATERIALE MATERIAL

Banda Band	Acciaio inossidabile Stainless steel AISI 430
Cassetto Housing	Acciaio inossidabile Stainless steel AISI 430
Vite Screw	Acciaio zincato Zinc-plated steel

LARG. NASTRO BAND WIDTH	DIAM. DIAM.	SPESSORE THICKNESS	COPPIA DI SERRAGGIO RACCOMANDATA RECOMMENDED TIGHTENING TORQUE	SCATOLE BOX
A	B	C	Nm	pz/nrm
mm	mm	mm		

9
mm

W2A09008012000	9	8-12	0,8	2,6	100
W2A09010016000	9	10-16	0,8	2,6	100
W2A09012020000	9	12-20	0,8	2,6	100
W2A09016025000	9	16-25	0,8	4,0	100
W2A09016027000	9	16-27	0,8	4,0	100
W2A09020032000	9	20-32	0,8	4,0	100
W2A09025040000	9	25-40	0,8	4,0	100
W2A09035050000	9	32-50	0,8	4,0	50
W2A09040060000	9	40-60	0,8	4,0	50
W2A09050070000	9	50-70	0,8	4,0	50
W2A09060080000	9	60-80	0,8	4,0	50
W2A09070090000	9	70-90	0,8	4,0	25
W2A09080100000	9	80-100	0,8	4,0	25
W2A09090110000	9	90-110	0,8	4,0	25
W2A09100120000	9	100-120	0,8	4,0	25
W2A09110130000	9	110-130	0,8	4,0	25
W2A09120140000	9	120-140	0,8	4,0	25
W2A09130150000	9	130-150	0,8	4,0	25

12
mm

W2B12012020000	12	12-20	1,0	6,5	100
W2B12016025000	12	16-25	1,0	6,5	100
W2B12016027000	12	16-27	1,0	6,5	100
W2B12020032000	12	20-32	1,0	6,5	100
W2B12025040000	12	25-40	1,0	6,5	100
W2B12035050000	12	32-50	1,0	6,5	50
W2B12040060000	12	40-60	1,0	6,5	50
W2B12050070000	12	50-70	1,0	6,5	50
W2B12060080000	12	60-80	1,0	6,5	50
W2B12070090000	12	70-90	1,0	6,5	25
W2B12080100000	12	80-100	1,0	6,5	25
W2B12090110000	12	90-110	1,0	6,5	25
W2B12100120000	12	100-120	1,0	6,5	25
W2B12110130000	12	110-130	1,0	6,5	25
W2B12120140000	12	120-140	1,0	6,5	25
W2B12130150000	12	130-150	1,0	6,5	25
W2B12140160000	12	140-160	1,0	6,5	25
W2B12150170000	12	150-170	1,0	6,5	25
W2B12160180000	12	160-180	1,0	6,5	25
W2B12170190000	12	170-190	1,0	6,5	25
W2B12180200000	12	180-200	1,0	6,5	25

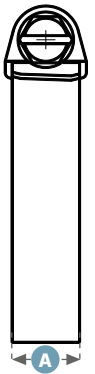
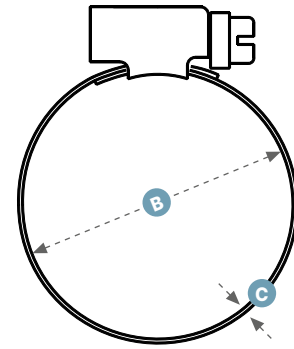

**IMPIEGO
APPLICATIONS**

Nautica Marine
Alimentare Food



**DESCRIZIONE
DESCRIPTION**

Fascetta ad altissima tenuta, compatta e resistente. La banda interna liscia ed i bordi rialzati, conferiscono assoluta sicurezza al tubo. Conforme alla normativa DIN 3017.

High resistant clamp, compact and durable. Rolle-up band edges and smooth band underside are able to guarantee total protection to the hose. According to DIN 3017.



**MATERIALE
MATERIAL**

Banda Band	Acciaio inossidabile Stainless steel AISI 304
Cassetto Housing	Acciaio inossidabile Stainless steel AISI 304
Vite Screw	Acciaio zincato Zinc-plated steel

LARG. NASTRO BAND WIDTH	DIAM. DIAM.	SPESSORE THICKNESS	COPPIA DI SERRAGGIO RACCOMANDATA RECOMMENDED TIGHTENING TORQUE	SCATOLE BOX
A	B	C	Nm	pz/nrm

**9
mm**

W4A09008012000	9	8-12	0,8	2,6	100
W4A09010016000	9	10-16	0,8	2,6	100
W4A09012020000	9	12-20	0,8	2,6	100
W4A09016025000	9	16-25	0,8	4,0	100
W4A09016027000	9	16-27	0,8	4,0	100
W4A09020032000	9	20-32	0,8	4,0	100
W4A09025040000	9	25-40	0,8	4,0	100
W4A09035050000	9	32-50	0,8	4,0	50
W4A09040060000	9	40-60	0,8	4,0	50
W4A09050070000	9	50-70	0,8	4,0	50
W4A09060080000	9	60-80	0,8	4,0	50
W4A09070090000	9	70-90	0,8	4,0	25
W4A09080100000	9	80-100	0,8	4,0	25
W4A09090110000	9	90-110	0,8	4,0	25
W4A09100120000	9	100-120	0,8	4,0	25
W4A09110130000	9	110-130	0,8	4,0	25
W4A09120140000	9	120-140	0,8	4,0	25
W4A09130150000	9	130-150	0,8	4,0	25

**12
mm**

W4B12012020000	12	12-20	1,0	6,5	100
W4B12016025000	12	16-25	1,0	6,5	100
W4B12016027000	12	16-27	1,0	6,5	100
W4B12020032000	12	20-32	1,0	6,5	100
W4B12025040000	12	25-40	1,0	6,5	100
W4B12035050000	12	32-50	1,0	6,5	50
W4B12040060000	12	40-60	1,0	6,5	50
W4B12050070000	12	50-70	1,0	6,5	50
W4B12060080000	12	60-80	1,0	6,5	50
W4B12070090000	12	70-90	1,0	6,5	25
W4B12080100000	12	80-100	1,0	6,5	25
W4B12090110000	12	90-110	1,0	6,5	25
W4B12100120000	12	100-120	1,0	6,5	25
W4B12110130000	12	110-130	1,0	6,5	25
W4B12120140000	12	120-140	1,0	6,5	25
W4B12130150000	12	130-150	1,0	6,5	25
W4B12140160000	12	140-160	1,0	6,5	25
W4B12150170000	12	150-170	1,0	6,5	25
W4B12160180000	12	160-180	1,0	6,5	25
W4B12170190000	12	170-190	1,0	6,5	25
W4B12180200000	12	180-200	1,0	6,5	25

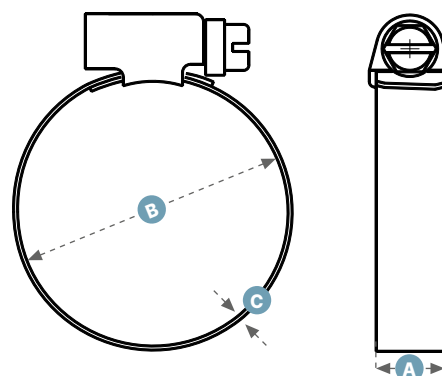

IMPIEGO APPLICATIONS

Nautica Marine
Alimentare Food

DESCRIZIONE DESCRIPTION

Fascetta ad altissima tenuta, compatta e resistente. La banda interna liscia ed i bordi rialzati, conferiscono assoluta sicurezza al tubo. Conforme alla normativa DIN 3017.

High resistant clamp, compact and durable. Rolle-up band edges and smooth band underside are able to guarantee total protection to the hose. According to DIN 3017.

MATERIALE MATERIAL

Banda Band	Acciaio inossidabile Stainless steel AISI 304
Cassetto Housing	Acciaio inossidabile Stainless steel AISI 304
Vite Screw	Acciaio inossidabile Stainless steel AISI 304

LARG. NASTRO BAND WIDTH	DIAM. DIAM.	SPESSORE THICKNESS	COPPIA DI SERRAGGIO RACCOMANDATA RECOMMENDED TIGHTENING TORQUE	SCATOLE BOX
A	B	C	Nm	pz/nrm
mm	mm	mm		

9
mm

W4A09008012000	9	8-12	0,8	2,6	100
W4A09010016000	9	10-16	0,8	2,6	100
W4A09012020000	9	12-20	0,8	2,6	100
W4A09016025000	9	16-25	0,8	4,0	100
W4A09016027000	9	16-27	0,8	4,0	100
W4A09020032000	9	20-32	0,8	4,0	100
W4A09025040000	9	25-40	0,8	4,0	100
W4A09035050000	9	32-50	0,8	4,0	50
W4A09040060000	9	40-60	0,8	4,0	50
W4A09050070000	9	50-70	0,8	4,0	50
W4A09060080000	9	60-80	0,8	4,0	50
W4A09070090000	9	70-90	0,8	4,0	25
W4A09080100000	9	80-100	0,8	4,0	25
W4A09090110000	9	90-110	0,8	4,0	25
W4A09100120000	9	100-120	0,8	4,0	25
W4A09110130000	9	110-130	0,8	4,0	25
W4A09120140000	9	120-140	0,8	4,0	25
W4A09130150000	9	130-150	0,8	4,0	25

12
mm

W4B12012020000	12	12-20	1,0	6,5	100
W4B12016025000	12	16-25	1,0	6,5	100
W4B12016027000	12	16-27	1,0	6,5	100
W4B12020032000	12	20-32	1,0	6,5	100
W4B12025040000	12	25-40	1,0	6,5	100
W4B12035050000	12	32-50	1,0	6,5	50
W4B12040060000	12	40-60	1,0	6,5	50
W4B12050070000	12	50-70	1,0	6,5	50
W4B12060080000	12	60-80	1,0	6,5	50
W4B12070090000	12	70-90	1,0	6,5	25
W4B12080100000	12	80-100	1,0	6,5	25
W4B12090110000	12	90-110	1,0	6,5	25
W4B12100120000	12	100-120	1,0	6,5	25
W4B12110130000	12	110-130	1,0	6,5	25
W4B12120140000	12	120-140	1,0	6,5	25
W4B12130150000	12	130-150	1,0	6,5	25
W4B12140160000	12	140-160	1,0	6,5	25
W4B12150170000	12	150-170	1,0	6,5	25
W4B12160180000	12	160-180	1,0	6,5	25
W4B12170190000	12	170-190	1,0	6,5	25
W4B12180200000	12	180-200	1,0	6,5	25

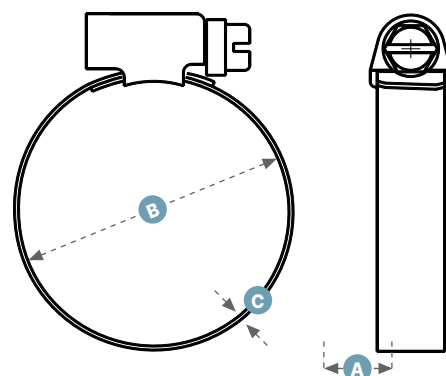

IMPIEGO APPLICATIONS

Nautica	Marine
Petrolchimica	Petrochemical
Alimentare	Food



DESCRIZIONE DESCRIPTION

Fascetta ad altissima tenuta, compatta e resistente. La banda interna liscia ed i bordi rialzati, conferiscono assoluta sicurezza al tubo. Conforme alla normativa DIN 3017.

High resistant clamp, compact and durable. Rolle-up band edges and smooth band underside are able to guarantee total protection to the hose. According to DIN 3017.



MATERIALE MATERIAL

Banda Band	Acciaio inossidabile Stainless steel AISI 316
Cassetto Housing	Acciaio inossidabile Stainless steel AISI 316
Vite Screw	Acciaio inossidabile Stainless steel AISI 316

LARG. NASTRO BAND WIDTH	DIAM. DIAM.	SPESSORE THICKNESS	COPPIA DI SERRAGGIO RACCOMANDATA RECOMMENDED TIGHTENING TORQUE	SCATOLE BOX
A	B	C	Nm	pz/nrm
mm	mm	mm		

9
mm

W5A09008012000	9	8-12	0,8	2,6	100
W5A09010016000	9	10-16	0,8	2,6	100
W5A09012020000	9	12-20	0,8	2,6	100
W5A09016025000	9	16-25	0,8	4,0	100
W5A09016027000	9	16-27	0,8	4,0	100
W5A09020032000	9	20-32	0,8	4,0	100
W5A09025040000	9	25-40	0,8	4,0	100
W5A09035050000	9	32-50	0,8	4,0	50
W5A09040060000	9	40-60	0,8	4,0	50
W5A09050070000	9	50-70	0,8	4,0	50
W5A09060080000	9	60-80	0,8	4,0	50
W5A09070090000	9	70-90	0,8	4,0	25
W5A09080100000	9	80-100	0,8	4,0	25
W5A09090110000	9	90-110	0,8	4,0	25
W5A09100120000	9	100-120	0,8	4,0	25
W5A09011013000	9	110-130	0,8	4,0	25
W5A09012014000	9	120-140	0,8	4,0	25
W5A09013015000	9	130-150	0,8	4,0	25

12
mm

W5B12012020000	12	12-20	1,0	6,5	100
W5B12016025000	12	16-25	1,0	6,5	100
W5B12016027000	12	16-27	1,0	6,5	100
W5B12020032000	12	20-32	1,0	6,5	100
W5B12025040000	12	25-40	1,0	6,5	100
W5B12035050000	12	32-50	1,0	6,5	50
W5B12040060000	12	40-60	1,0	6,5	50
W5B12050070000	12	50-70	1,0	6,5	50
W5B12060080000	12	60-80	1,0	6,5	50
W5B12070090000	12	70-90	1,0	6,5	25
W5B12080100000	12	80-100	1,0	6,5	25
W5B12090110000	12	90-110	1,0	6,5	25
W5B12100120000	12	100-120	1,0	6,5	25
W5B12110130000	12	110-130	1,0	6,5	25
W5B12120140000	12	120-140	1,0	6,5	25
W5B12130150000	12	130-150	1,0	6,5	25
W5B12140160000	12	140-160	1,0	6,5	25
W5B12150170000	12	150-170	1,0	6,5	25
W5B12160180000	12	160-180	1,0	6,5	25
W5B12170190000	12	170-190	1,0	6,5	25
W5B12180200000	12	180-200	1,0	6,5	25

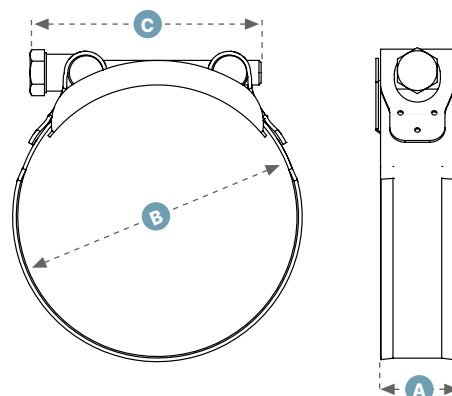

IMPIEGO APPLICATIONS

Industria in genere	Industry in general
Macchine agricole	Agriculture machine
Edilizia	Construction
Irrigazione	Irrigation

DESCRIZIONE DESCRIPTION

Collari ad altissima prestazione. Adatti particolarmente per tubazioni di grosso diametro, molto robuste e rigide. I bordi rialzati, conferiscono assoluta sicurezza al tubo.

High performance collars, compact and durable. Rolle-up band edges are able to guarantee total protection to the hose.

MATERIALE MATERIAL

Banda Band	Acciaio inossidabile Stainless steel AISI 430
Guida Guide	Acciaio inossidabile Stainless steel AISI 430
Vite Screw	Acciaio zincato Zinc-plated steel

LARG. NASTRO BAND WIDTH	DIAM. DIAM.	SPESSORE THICKNESS	COPPIA DI SERRAGGIO RACCOMANDATA RECOMMENDED TIGHTENING TORQUE	SCATOLE BOX
A	B	C	Nm	pz/nrm
mm	mm	mm		

21 mm	WC221026028000	21	26-28	M6x50	10,4	50
	WC221029031000	21	29-31	M6x50	10,4	50
	WC221032035000	21	32-35	M6x50	10,4	50
	WC221036039000	21	36-39	M6x50	10,4	50
	WC221040043000	21	40-43	M6x50	10,4	50
	WC221044047000	21	44-47	M6x50	10,4	50
	WC221048051000	21	48-51	M6x60	10,4	50
	WC221052055000	21	52-55	M6x60	10,4	50
	WC221056059000	21	56-59	M6x60	10,4	50
	WC221060063000	21	60-63	M6x60	10,4	50
WC221064067000	21	64-67	M6x55	10,4	50	

24 mm	WC224068073000	24	68-73	M8x70	24,6	25
	WC224074079000	24	74-79	M8x70	24,6	25
	WC224080085000	24	80-85	M8x70	24,6	25
	WC224086091000	24	86-91	M8x80	24,6	25
	WC224092097000	24	92-97	M8x80	24,6	25
	WC224098103000	24	98-103	M8x80	24,6	25
	WC224104112000	24	104-112	M8x90	24,6	25
	WC224113121000	24	113-121	M8x90	24,6	25
	WC224122130000	24	122-130	M8x90	24,6	25

26 mm	WC226131139000	26	131-139	M10x100	50,1	20
	WC226140148000	26	140-148	M10x100	50,1	20
	WC226149161000	26	149-161	M10x100	50,1	20
	WC226162174000	26	162-174	M10x100	50,1	20
	WC226175187000	26	175-187	M10x100	50,1	10
	WC226188200000	26	188-200	M10x100	50,1	10
	WC226201213000	26	201-213	M10x100	50,1	10
	WC226214226000	26	214-226	M10x100	50,1	10
	WC226227239000	26	227-239	M10x100	50,1	10
	WC226240252000	26	240-252	M10x100	50,1	10

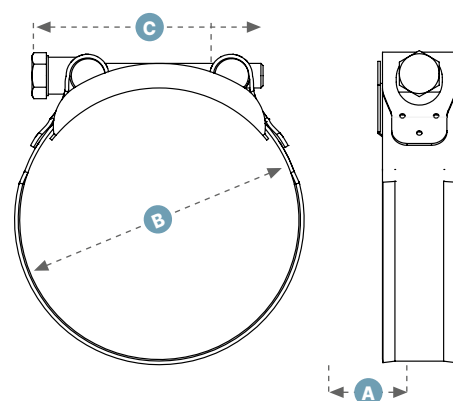

IMPIEGO APPLICATIONS

Nautica	Marine
Petrolchimica	Petrochemical
Alimentare	Food



DESCRIZIONE DESCRIPTION

Collari ad altissima prestazione. Adatti particolarmente per tubazioni di grosso diametro, molto robuste e rigide. I bordi rialzati, conferiscono assoluta sicurezza al tubo.

High performance collars, compact and durable. Rolle-up band edges are able to guarantee total protection to the hose.



MATERIALE MATERIAL

Banda / Band	Acciaio inossidabile Stainless steel AISI 304
Guida / Guide	Acciaio inossidabile Stainless steel AISI 304
Vite / Screw	Acciaio inossidabile Stainless steel AISI 304

LARG. NASTRO BAND WIDTH	DIAM. DIAM.	SPESSORE THICKNESS	COPPIA DI SERRAGGIO RACCOMANDATA RECOMMENDED TIGHTENING TORQUE	SCATOLE BOX
A	B	C	Nm	pz/nrm

21
mm

WC421026028000	21	26-28	M6×50	5,9/10,4	50
WC421029031000	21	29-31	M6×50	5,9/10,4	50
WC421032035000	21	32-35	M6×50	5,9/10,4	50
WC421036039000	21	36-39	M6×50	5,9/10,4	50
WC421040043000	21	40-43	M6×50	5,9/10,4	50
WC421044047000	21	44-47	M6×50	5,9/10,4	50
WC421048051000	21	48-51	M6×60	5,9/10,4	50
WC421052055000	21	52-55	M6×60	5,9/10,4	50
WC421056059000	21	56-59	M6×60	5,9/10,4	50
WC421060063000	21	60-63	M6×60	5,9/10,4	50
WC421064067000	21	64-67	M6×60	5,9/10,4	50

24
mm

WC424068073000	24	68-73	M8×70	14,5/25,5	25
WC424074079000	24	74-79	M8×70	14,5/25,5	25
WC424080085000	24	80-85	M8×70	14,5/25,5	25
WC424086091000	24	86-91	M8×80	14,5/25,5	25
WC424092097000	24	93-97	M8×80	14,5/25,5	25
WC424098103000	24	98-103	M8×80	14,5/25,5	25
WC424104112000	24	104-112	M8×90	14,5/25,5	25
WC424113121000	24	113-121	M8×90	14,5/25,5	25
WC424122130000	24	122-130	M8×90	14,5/25,5	25

26
mm

WC426131139000	26	131-139	M8×100	14,5/25,5	20
WC426140148000	26	140-148	M8×100	14,5/25,5	20
WC426149161000	26	149-161	M8×100	14,5/25,5	20
WC426162174000	26	162-174	M8×100	14,5/25,5	20
WC426175187000	26	175-187	M8×100	14,5/25,5	10
WC426188200000	26	188-200	M8×100	14,5/25,5	10
WC426201213000	26	201-213	M8×100	14,5/25,5	10
WC426214226000	26	214-226	M8×100	14,5/25,5	10
WC426227239000	26	227-239	M8×100	14,5/25,5	10
WC426240252000	26	240-252	M8×100	14,5/25,5	10

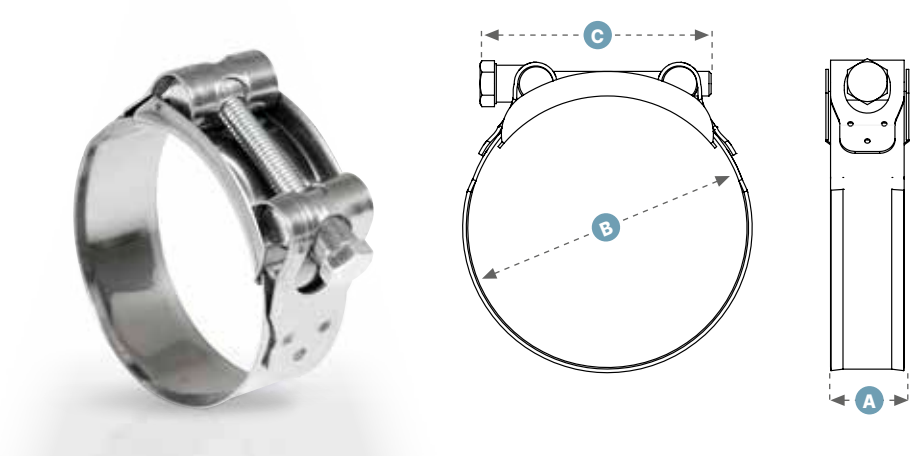

IMPIEGO APPLICATIONS

Nautica Marine
 Petrolchimica Petrochemical
 Alimentare Food

DESCRIZIONE DESCRIPTION

Collari ad altissima prestazione. Adatti particolarmente per tubazioni di grosso diametro, molto robuste e rigide. I bordi rialzati, conferiscono assoluta sicurezza al tubo.

High performance collars, compact and durable. Rolle-up band edges are able to guarantee total protection to the hose.

MATERIALE MATERIAL

Banda Band	Acciaio inossidabile Stainless steel AISI 316
Guida Guide	Acciaio inossidabile Stainless steel AISI 316
Vite Screw	Acciaio inossidabile Stainless steel AISI 316

		LARG. NASTRO BAND WIDTH A mm	DIAM. DIAM. B mm	SPESSORE THICKNESS C mm	COPPIA DI SERRAGGIO RACCOMANDATA RECOMMENDED TIGHTENING TORQUE Nm	SCATOLE BOX RECOMMENDED TIGHTENING TORQUE
21 mm	WC521023025000	21	23-25	M6	10	50
	WC521026028000	21	26-28	M6	10	50
	WC521029031000	21	29-31	M6	10	50
	WC521032035000	21	32-35	M6	10	50
	WC521036039000	21	36-39	M6	10	50
	WC521040043000	21	40-43	M6	10	50
	WC521044047000	21	44-47	M6	10	50
	WC521048051000	21	48-51	M6	10	50
	WC521052055000	21	52-55	M6	10	50
	WC521056059000	21	56-59	M6	10	50
WC521060063000	21	60-63	M6	10	50	
WC521064067000	21	64-67	M6	10	50	
24 mm	WC524068073000	24	68-73	M8	24	25
	WC524074079000	24	74-79	M8	24	25
	WC524080085000	24	80-85	M8	24	25
	WC524086091000	24	86-91	M8	24	25
	WC524092097000	24	92-97	M8	24	25
	WC524098103000	24	98-103	M8	24	25
	WC524104112000	24	104-112	M8	24	25
	WC524113121000	24	113-121	M8	24	25
	WC524122130000	24	122-130	M8	24	25
	26 mm	WC526131139000	26	131-139	M8	24
WC526140148000		26	140-148	M8	24	20
WC526149161000		26	149-161	M8	24	20
WC526162174000		26	162-174	M8	24	20
WC526175187000		26	175-187	M8	24	10
WC526188200000		26	188-200	M8	24	10
WC526201213000		26	201-213	M8	24	10
WC526214226000		26	214-226	M8	24	10
WC526227239000		26	227-239	M8	24	10
WC526240252000		26	240-252	M8	24	10

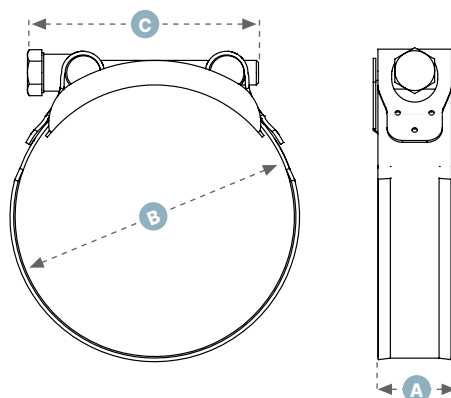

IMPIEGO APPLICATIONS

Nautica	Marine
Petrochimica	Petrochemical
Alimentare	Food



DESCRIZIONE DESCRIPTION

Collari ad altissima prestazione. Adatti particolarmente per tubazioni di grosso diametro, molto robuste e rigide. I bordi rialzati, conferiscono assoluta sicurezza al tubo.

High performance collars, compact and durable. Rolle-up band edges are able to guarantee total protection to the hose.



MATERIALE MATERIAL

Banda Band	Acciaio inossidabile Stainless steel AISI 430
Guida Guide	Acciaio inossidabile Stainless steel AISI 430
Vite Screw	Acciaio inossidabile Stainless steel AISI 430

LARG. NASTRO BAND WIDTH	DIAM. DIAM.	SPESSORE THICKNESS	COPPIA DI SERRAGGIO RACCOMANDATA RECOMMENDED TIGHTENING TORQUE	SCATOLE BOX
A	B	C	Nm	moq*
mm	mm	mm		

26 mm

WC2C26245260000	26	245-260	M10	24	1-10
WC2C26250265000	26	250-265	M10	24	1-10
WC2C26255270000	26	255-270	M10	24	1-10
WC2C26260275000	26	260-275	M10	24	1-10
WC2C26265280000	26	265-280	M10	24	1-10
WC2C26270285000	26	270-285	M10	24	1-10
WC2C26275290000	26	275-290	M10	24	1-10
WC2C26280295000	26	280-295	M10	24	1-10
WC2C26285300000	26	285-300	M10	24	1-10
WC2C26290305000	26	290-305	M10	24	1-10
WC2C26295310000	26	295-310	M10	24	1-10
WC2C26295310000	26	300-315	M10	24	1-10
WC2C26305320000	26	305-320	M10	24	1-10
WC2C26310325000	26	310-325	M10	24	1-10
WC2C26315330000	26	315-330	M10	24	1-10
WC2C26320335000	26	320-335	M10	24	1-10
WC2C26325340000	26	325-340	M10	24	1-10
WC2C26335350000	26	335-350	M10	24	1-10
WC2C26340355000	26	340-355	M10	24	1-10
WC2C26345360000	26	345-360	M10	24	1-10
WC2C26350365000	26	350-365	M10	24	1-10
WC2C26360375000	26	360-375	M10	24	1-10
WC2C26375390000	26	375-390	M10	24	1-10
WC2C26390405000	26	390-405	M10	24	1-10
WC2C26395410000	26	395-410	M10	24	1-10
WC2C26400415000	26	400-415	M10	24	1-10
WC2C26410425000	26	405-420	M10	24	1-10
WC2C26410425000	26	410-425	M10	24	1-10
WC2C26415430000	26	415-430	M10	24	1-10
WC2C26425440000	26	425-440	M10	24	1-10
WC2C26430445000	26	430-445	M10	24	1-10
WC2C26435450000	26	435-450	M10	24	1-10
WC2C26440455000	26	440-455	M10	24	1-10
WC2C26450465000	26	450-465	M10	24	1-10
WC2C26465480000	26	465-480	M10	24	1-10
WC2C26490505000	26	490-505	M10	24	1-10
WC2C26500515000	26	500-515	M10	24	1-10
WC2C26510525000	26	510-525	M10	24	1-10
WC2C26515530000	26	515-530	M10	24	1-10
WC2C26520535000	26	520-535	M10	24	1-10
WC2C26535550000	26	535-550	M10	24	1-10
WC2C26550565000	26	550-565	M10	24	1-10
WC2C26590605000	26	590-605	M10	24	1-10
WC2C26600615000	26	600-615	M10	24	1-10
WC2C26610625000	26	610-625	M10	24	1-10
WC2C26695710000	26	695-710	M10	24	1-10
WC2C26700715000	26	700-715	M10	24	1-10
WC2C26790805000	26	790-805	M10	24	1-10

* Minimum Order Quantity

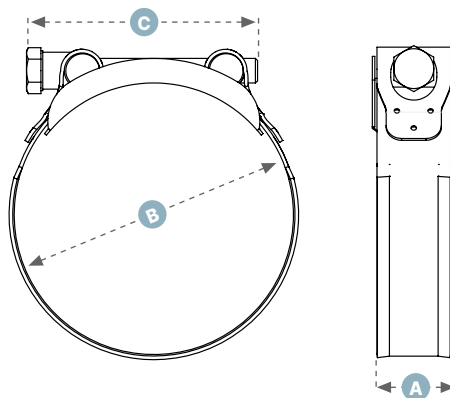

IMPIEGO APPLICATIONS

Nautica Marine
Alimentare Food

DESCRIZIONE DESCRIPTION

Collari ad altissima prestazione. Adatti particolarmente per tubazioni di grosso diametro, molto robuste e rigide. I bordi rialzati, conferiscono assoluta sicurezza al tubo.

High performance collars, compact and durable. Rolle-up band edges are able to guarantee total protection to the hose.

MATERIALE MATERIAL

Banda Band	Acciaio inossidabile Stainless steel AISI 304
Guida Guide	Acciaio inossidabile Stainless steel AISI 304
Vite Screw	Acciaio inossidabile Stainless steel AISI 304

		LARG. NASTRO BAND WIDTH	DIAM. DIAM.	SPESSORE THICKNESS	COPPIA DI SERRAGGIO RACCOMANDATA RECOMMENDED TIGHTENING TORQUE	SCATOLE BOX
		A mm	B mm	C mm	Nm	moq*
26 mm	WC4C26245260000	26	245-260	M8	24	1-10
	WC4C26250265000	26	250-265	M8	24	1-10
	WC4C26255270000	26	255-270	M8	24	1-10
	WC4C26260275000	26	260-275	M8	24	1-10
	WC4C26265280000	26	265-280	M8	24	1-10
	WC4C26270285000	26	270-285	M8	24	1-10
	WC4C26275290000	26	275-290	M8	24	1-10
	WC4C26280295000	26	280-295	M8	24	1-10
	WC4C26285300000	26	285-300	M8	24	1-10
	WC4C26290305000	26	290-305	M8	24	1-10
	WC4C26295310000	26	295-310	M8	24	1-10
	WC4C26295310000	26	300-315	M8	24	1-10
	WC4C26305320000	26	305-320	M8	24	1-10
	WC4C26310325000	26	310-325	M8	24	1-10
	WC4C26315330000	26	315-330	M8	24	1-10
	WC4C26320335000	26	320-335	M8	24	1-10
	WC4C26325340000	26	325-340	M8	24	1-10
	WC4C26335350000	26	335-350	M8	24	1-10
	WC4C26340355000	26	340-355	M8	24	1-10
	WC4C26345360000	26	345-360	M8	24	1-10
	WC4C26350365000	26	350-365	M8	24	1-10
	WC4C26360375000	26	360-375	M8	24	1-10
	WC4C26375390000	26	375-390	M8	24	1-10
	WC4C26390405000	26	390-405	M8	24	1-10
	WC4C26395410000	26	395-410	M8	24	1-10
	WC4C26400415000	26	400-415	M8	24	1-10
	WC4C26410425000	26	405-420	M8	24	1-10
	WC4C26410425000	26	410-425	M8	24	1-10
WC4C26415430000	26	415-430	M8	24	1-10	
WC4C26425440000	26	425-440	M8	24	1-10	
WC4C26430445000	26	430-445	M8	24	1-10	
WC4C26435450000	26	435-450	M8	24	1-10	
WC4C26440455000	26	440-455	M8	24	1-10	
WC4C26450465000	26	450-465	M8	24	1-10	
WC4C26465480000	26	465-480	M8	24	1-10	
WC4C26490505000	26	490-505	M8	24	1-10	
WC4C26500515000	26	500-515	M8	24	1-10	
WC4C26510525000	26	510-525	M8	24	1-10	
WC4C26515530000	26	515-530	M8	24	1-10	
WC4C26520535000	26	520-535	M8	24	1-10	
WC4C26535550000	26	535-550	M8	24	1-10	
WC4C26550565000	26	550-565	M8	24	1-10	
WC4C26590605000	26	590-605	M8	24	1-10	
WC4C26600615000	26	600-615	M8	24	1-10	
WC4C26610625000	26	610-625	M8	24	1-10	
WC4C26695710000	26	695-710	M8	24	1-10	
WC4C26700715000	26	700-715	M8	24	1-10	
WC4C26790805000	26	790-805	M8	24	1-10	

* Minimum Order Quantity

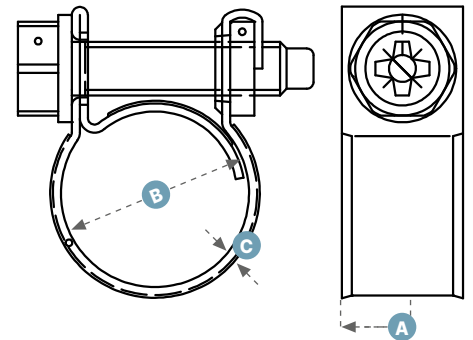

IMPIEGO APPLICATIONS

Industria in genere Macchine agricole Ciclomotori Automotive	Industry in general Agriculture machine Motorcycles Automotive
---	---



DESCRIZIONE DESCRIPTION

Il collare benzina mini ha un nastro a bordi rialzati per non danneggiare il tubo. La linguetta inferiore è munita di rinforzo. Un altro dettaglio pratico è la testa esagonale della vite, dotata di intaglio e adatta per l'utilizzo di un cacciavite flessibile. È particolarmente indicato per tubi di piccolo diametro e di spessore ridotto.

This clamp features rolled-up band edges that are gentle on hoses. The band tongue that fits under the hose is profiled for added strength.



MATERIALE MATERIAL

Banda Band	Acciaio zincato Zinc-plated steel
Chiave Bolt	7 mm
Vite Screw	Acciaio zincato Zinc-plated steel AISI 430

	LARG. NASTRO BAND WIDTH	DIAM. DIAM.	SPESSORE THICKNESS	COPPIA DI SERRAGGIO RACCOMANDATA RECOMMENDED TIGHTENING TORQUE	SCATOLE BOX
	A	B	C	Nm	pz/nrm
	mm	mm	mm		

**9
mm**

WCM007009	9	7-9	0,6	1,2	2000
WCM009010	9	9-10	0,6	1,2	2000
WCM100000	9	8,5-11	0,6	1,2	2000
WCM110000	9	9,5-12	0,6	1,2	2000
WCM120000	9	11-13	0,6	1,2	3000
WCM130000	9	11,5-14	0,6	1,2	3000
WCM140000	9	13-15	0,6	1,2	3000
WCM150000	9	14-16	0,6	1,2	3000
WCM160000	9	15-17	0,6	1,2	3000
WCM170000	9	16-18	0,6	1,2	2500
WCM180000	9	17-19	0,6	1,2	2500
WCM190000	9	18-21	0,6	1,2	2500
WCM200000	9	19-21	0,6	1,2	2500
WCM290000	9	24-29	0,6	1,2	1200

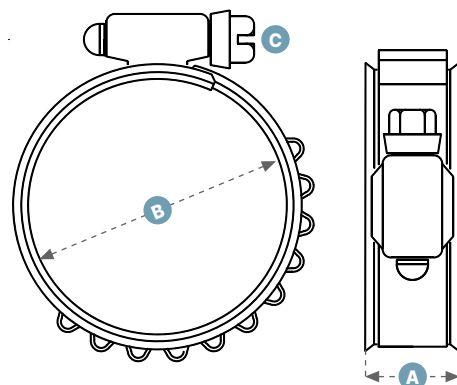

IMPIEGO APPLICATIONS

Industria in genere	Industry in general
Macchine agricole	Agriculture machine
Edilizia	Construction
Nautica	Marine
Militare	Military
Automotive	Automotive

DESCRIZIONE DESCRIPTION

Le fascette con anello interno SAE tipo T WTS hanno una perfetta tenuta in applicazioni su manicotti soggetti a dilatazioni termiche e rilassamento del tubo. La particolare costruzione garantisce una tensione costante grazie all'effetto combinato dell'anello interno e della banda convoluta. La finitura superficiale con elettrolucidatura garantisce una migliore resistenza alla corrosione.

With a convoluted heat-treated band that provides spring-like tensioning effects for thermal cycling hose applications. This clamp concentrates band-sealing pressure, increasing performance up to 30% compared to standard smooth liners. Flanged edges protect soft hose compounds from abrasion and wear.

MATERIALE MATERIAL

Banda Band	Acciaio inossidabile Stainless steel AISI 304
Cassetto Housing	Acciaio inossidabile Stainless steel SERIES 300
Vite Screw	Acciaio inossidabile Stainless steel SERIES 300

LARG. NASTRO BAND WIDTH	DIAM. DIAM.	SPESSORE THICKNESS	COPPIA DI SERRAGGIO RACCOMANDATA RECOMMENDED TIGHTENING TORQUE	SCATOLE BOX
A	B	C		
mm	mm	mm	Nm	pz/nrm

**16
mm**

WTS028038	16,51	28-38	8	5,6	400
WTS030041	16,51	30-41	8	5,6	400
WTS035048	16,51	35-48	8	5,6	400
WTS040054	16,51	40-54	8	5,6	300
WTS041060	16,51	41-60	8	5,6	300
WTS046067	16,51	46-67	8	5,6	200
WTS050073	16,51	50-73	8	5,6	200
WTS057079	16,51	57-79	8	5,6	200
WTS064086	16,51	64-86	8	5,6	200
WTS070092	16,51	70-92	8	5,6	200
WTS076098	16,51	76-98	8	5,6	200
WTS083105	16,51	83-105	8	5,6	200
WTS089111	16,51	89-111	8	5,6	200
WTS095118	16,51	95-118	8	5,6	200
WTS108130	16,51	108-130	8	5,6	200
WTS121143	16,51	121-143	8	5,6	100
WTS146148	16,51	146-168	8	5,6	100
WTS159181	16,51	159-181	8	5,6	100
WTS184206	16,51	184-206	8	5,6	100



IMPIEGO APPLICATIONS

Industria in genere Macchine agricole Edilizia Ciclomotori Automotive	Industry in general Agriculture machine Construction Motorcycles Automotive
---	---



DESCRIZIONE DESCRIPTION

Le fascette con anello interno SAE tipo F WDB sono particolarmente indicate per i circuiti di raffreddamento. L'anello interno garantisce una tenuta sicura su tubi in materiali morbidi creando un effetto oring tra fascetta, tubo e portagomma.

For air to air and coolant applications. The inner shield provides superb sealing characteristics and is safe for all soft hoses. It can also be found in the marine, agriculture, construction and off-highway markets.



MATERIALE MATERIAL

Banda Band	Acciaio inossidabile Stainless steel AISI 304
Cassetto Housing	Acciaio inossidabile Stainless steel SERIES 300
Vite Screw	Acciaio inossidabile Stainless steel SERIES 300

LARG. NASTRO BAND WIDTH	DIAM. DIAM.	SPESSORE THICKNESS	COPPIA DI SERRAGGIO RACCOMANDATA RECOMMENDED TIGHTENING TORQUE	SCATOLE BOX
A	B	C	Nm	pz/nrm
mm	mm	mm		

16
mm

WDB015034	16,51	15,9-34,9	8	3,4-4,5	400
WDB017041	16,51	17,5-41,4	8	3,4-4,5	400
WDB023047	16,51	23,8-47,6	8	3,4-4,5	400
WDB030054	16,51	30,2-54,0	8	3,4-4,5	400
WDB036060	16,51	36,5-60,3	8	3,4-4,5	300
WDB042066	16,51	42,9-66,7	8	3,4-4,5	300
WDB049073	16,51	49,2-73,0	8	3,4-4,5	300
WDB055079	16,51	55,6-79,4	8	3,4-4,5	300
WDB061085	16,51	61,9-85,7	8	3,4-4,5	300
WDB068092	16,51	68,3-92,1	8	3,4-4,5	300
WDB074098	16,51	74,6-98,4	8	3,4-4,5	200
WDB087111	16,51	87,3-111,1	8	3,4-4,5	200
WDB100123	16,51	100,0-123,8	8	3,4-4,5	200
WDB112136	16,51	112,7-136,5	8	3,4-4,5	200

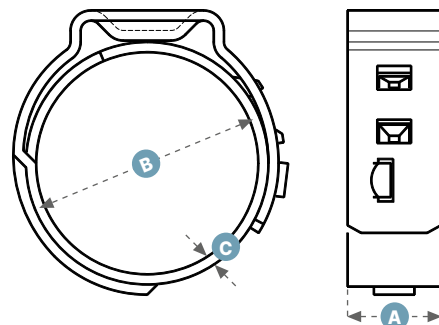

IMPIEGO APPLICATIONS

Nautica	Marine
Petrolchimica	Petrochemical
Ciclomotori	Motorcycles
Automotive	Automotive
Alimentare	Food
Beverage	Beverage



DESCRIZIONE DESCRIPTION

Le fascette pinzabili antigrinza WGT offrono facilità e velocità di montaggio e grazie alla loro costruzione, permettono un contatto a 360° con il tubo eliminando possibili punti di trafilamento. La fascetta è realizzata in acciaio inox AISI 304. Ideali per applicazioni su linee benzina, beverage, medicale e industria in genere.

These clamps offer 360° seamless fastening. Due to their seamless design and uniform compression sealing, these clamps are often used in the beverage, automotive, marine, and motorcycle industries. They are manufactured using 304 Stainless Steel and are perfect for poly and braided tubing.



MATERIALE MATERIAL

Banda Band	Acciaio inossidabile Stainless steel AISI 304
-------------------	--

LARG. NASTRO BAND WIDTH	DIAM. DIAM.	SPESORE THICKNESS	SCATOLE BOX
A	B	C	
mm	mm	mm	pz/nrm

**5
mm**

WGT05070	5	5,8-7,0	0,48	2500
WGT05080	5	6,8-8,0	0,48	2500
WGT05087	5	7,0-8,7	0,48	2500
WGT05090	5	7,3-9,0	0,48	2500
WGT05095	5	7,8-9,5	0,48	2500
WGT05100	5	8,3-10,0	0,48	2500
WGT05105	5	8,8-10,5	0,48	2500
WGT05109	5	9,2-10,9	0,48	2500
WGT05113	5	9,6-11,3	0,48	2500
WGT05118	5	10,1-11,8	0,48	2500

**7
mm**

WGT07123	7	9,8-12,3	0,56	2500
WGT07128	7	10,3-12,8	0,56	2500
WGT07133	7	10,8-13,3	0,56	2500
WGT07138	7	11,3-13,8	0,56	2500
WGT07140	7	11,5-14,0	0,56	2500
WGT07145	7	12,0-14,5	0,56	2500
WGT07148	7	12,3-14,8	0,56	2500
WGT07153	7	12,8-15,3	0,56	2500
WGT07157	7	13,2-15,7	0,56	2500
WGT07162	7	13,7-16,2	0,56	2500
WGT07164	7	13,9-16,4	0,56	2500
WGT07170	7	14,5-17,0	0,56	2500
WGT07180	7	15,5-18,0	0,56	2500
WGT07185	7	16,0-18,5	0,56	2500
WGT07192	7	16,0-19,2	0,56	A RICHIESTA ON DEMAND
WGT07198	7	16,6-19,8	0,56	A RICHIESTA ON DEMAND
WGT07210	7	17,8-21,0	0,56	A RICHIESTA ON DEMAND
WGT07226	7	19,4-22,6	0,56	A RICHIESTA ON DEMAND
WGT07235	7	20,3-23,5	0,56	A RICHIESTA ON DEMAND
WGT07241	7	20,9-24,1	0,56	A RICHIESTA ON DEMAND
WGT07256	7	22,4-25,6	0,56	A RICHIESTA ON DEMAND
WGT07271	7	23,9-27,1	0,56	A RICHIESTA ON DEMAND
WGT07286	7	25,4-28,6	0,56	A RICHIESTA ON DEMAND
WGT07301	7	26,9-30,1	0,56	A RICHIESTA ON DEMAND
WGT07308	7	27,6-30,8	0,56	A RICHIESTA ON DEMAND
WGT07316	7	28,4-31,6	0,56	A RICHIESTA ON DEMAND
WGT07331	7	29,9-33,1	0,56	A RICHIESTA ON DEMAND
WGT07346	7	31,4-34,6	0,56	A RICHIESTA ON DEMAND
WGT07361	7	32,9-36,1	0,56	A RICHIESTA ON DEMAND
WGT07376	7	34,4-37,6	0,56	A RICHIESTA ON DEMAND
WGT07381	7	34,9-38,1	0,56	A RICHIESTA ON DEMAND
WGT07396	7	36,4-39,6	0,56	A RICHIESTA ON DEMAND
WGT07410	7	37,8-41,0	0,56	A RICHIESTA ON DEMAND
WGT07455	7	42,3-45,5	0,56	A RICHIESTA ON DEMAND

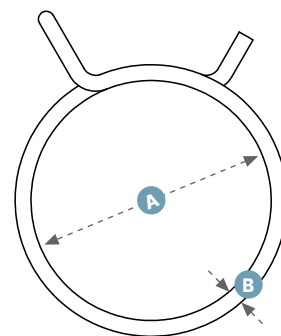

IMPIEGO APPLICATIONS

Industria in genere	Industry in general
Ciclomotori	Motorcycles
Automotive	Automotive



DESCRIZIONE DESCRIPTION

Fascette realizzate con un doppio filo di acciaio zincato; l'elasticità del materiale è in grado di compensare piccole variazioni diametrali. Ideali su tubi di spessori molto sottili e per tenute non gravose. Si raccomanda di utilizzare raccordi con rilievi sufficienti a contrastare il carico della fascetta ed evitare lo sfilamento del tubo.

Clamps made in double zinc-plated steel wire. Recommended on hoses of very thin thickness and forlight-duty works.



MATERIALE MATERIAL

Banda Band	Filo acciaio zincato Wire zinc-plated steel
------------	--

DIAM. DIAM.	Ø FILO Ø WIRE	SCATOLE BOX	SCATOLE BOX	SCATOLE BOX
A	B			
mm	mm	pz/nrm	pz/nrm	pz/nrm

WBS056007	6,6-7	1,0	25000	8300	2500
WBS070075	7-7,5	1,0	20000	8300	2000
WBS073078	7,3-7,8	1,0	20000	8300	2000
WBS078083	7,8-8,3	1,0	20000	8300	2000
WBS083088	8,3-8,8	1,0	12000	6600	1200
WBS088093	8,8-9,3	1,0	15000	5000	1500
WBS093098	9,3-9,8	1,0	15000	5000	1500
WBS098104	9,8-10,4	1,2	10000	3300	1000
WBS104110	10,4-11	1,2	10000	3300	1000
WBS110116	11-11,6	1,2	9000	3300	900
WBS116122	11,6-12,2	1,5	6000	2000	600
WBS122129	12,2-12,9	1,5	5000	2000	500
WBS124131	12,4-13,10	1,2	7000	2000	700
WBS129136	12,9-13,6	1,5	4500	2000	400
WBS133141	13,3-14,1	1,5	4000	1300	400
WBS136144	13,6-14,4	1,5	4000	1300	400
WBS144151	14,4-15,10	1,8	3000	1300	300
WBS148159	14,8-15,9	1,6	3500	1300	300
WBS151159	15,10-15,9	1,8	3000	1000	300
WBS154162	15,4-16,2	1,8	3000	1000	300
WBS159168	15,9-16,8	1,8	3000	1000	300
WBS168177	16,8-17,7	1,8	3000	1000	300
WBS177187	17,7-18,7	1,9	2200	700	200
WBS187195	18,7-19,5	2,0	2000	700	200
WBS196205	19,6-20,5	2,0	1500	700	200
WBS206216	20,6-21,6	2,0	1500	700	200
WBS215226	21,5-22,6	2,2	1300	500	100
WBS220231	22,0-23,1	2,2	1300	500	100
WBS224236	22,4-23,6	2,2	1200	400	100
WBS235247	23,5-24,7	2,2	1200	400	100
WBS245258	24,5-25,8	2,5	1000	300	100
WBS251264	25,1-26,4	2,5	900	300	100
WBS256269	25,6-26,9	2,5	800	300	100
WBS267281	26,7-28,1	2,5	750	250	100
WBS279294	27,9-29,4	2,5	750	250	100
WBS293309	29,3-30,9	2,8	750	200	100
WBS304320	30,4-32	2,8	500	200	100
WBS318334	31,8-33,4	2,8	500	200	100
WBS332348	33,2-34,8	2,8	450	200	100
WBS339357	33,9-35,7	2,8	500	200	100
WBS346364	34,6-36,4	3,0	450	200	100
WBS362380	36,2-38	3,0	450	200	100
WBS377397	37,7-39,7	3,2	400	200	100
WBS385405	38,5-40,5	3,2	400	200	100
WBS389408	38,9-40,8	3,2	350	-	-
WBS394414	39,4-41,4	3,2	350	-	-
WBS407423	40,7-42,3	3,2	350	-	-
WBS410432	41-43,2	3,2	300	-	-
WBS428450	42,8-45	3,2	300	-	-
WBS446468	44,6-46,8	3,2	300	-	-
WBS465489	46,5-48,9	3,2	300	-	-
WBS488509	48,8-50,9	3,5	200	-	-
WBS506532	50,6-53,2	3,5	200	-	-
WBS527554	52,7-55,4	3,5	200	-	-
WBS560588	56-58,8	3,5	150	-	-
WBS582610	58,2-61	3,5	150	-	-

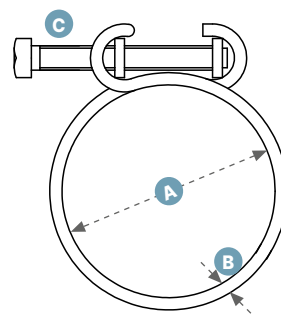

IMPIEGO APPLICATIONS

Industria in genere Industry in general
Automotive Automotive

DESCRIZIONE DESCRIPTION

Fascette consigliate per serrare tubi con spirali in rilievo. Sono realizzate con un doppio filo di acciaio zincato e garantiscono un serraggio ottimale anche in presenza di tubi molto morbidi e con spessori sottili.

Recommended for hoses with spirals in relief. The clamps are made with a double zinc-plated steel wire and they grant optimal clamping also on soft and thin hoses.

MATERIALE MATERIAL

Banda Band Acciaio zincato
Zinc-plated steel

LARG. NASTRO BAND WIDTH DIAM. DIAM. SPESSORE THICKNESS SCATOLE BOX

	A mm	B mm	C mm	pz/nrm
WBV012000	9,5-12	1,5	M3	2500
WBV013000	10,5-13	1,5	M3	2500
WBV014000	11,5-14	1,5	M3	2500
WBV015000	12,5-15	1,5	M3	2500
WBV016000	13-16	1,8	M3	3000
WBV017000	13,5-17	1,8	M3	3000
WBV018000	15-18	1,8	M3	3000
WBV019000	15,5-19	1,8	M3	2500
WBV020000	17-20	1,8	M3	2500
WBV021000	17,5-21	1,8	M3	2000
WBV022000	18,5-22	2,0	M4	1500
WBV023000	19-23	2,0	M4	1500
WBV025000	21,5-25	2,0	M4	1500
WBV027000	23,5-27	2,2	M4	1500
WBV029000	25-29	2,2	M4	1000
WBV031000	27-31	2,2	M4	1000
WBV033000	29-33	2,2	M4	1000
WBV035000	30,5-35	2,2	M4	1000
WBV037000	33-37	2,2	M4	1000
WBV040000	35,5-40	2,2	M4	800
WBV043000	38,5-43	2,2	M4	800
WBV046000	41-46	2,5	M5	500
WBV049000	43,5-49	2,5	M5	500
WBV053000	46,5-53	2,5	M5	400
WBV056000	50,5-56	2,5	M5	400
WBV060000	53,5-60	2,5	M6	400
WBV064000	56,5-64	2,8	M6	A RICHIESTA ON DEMAND
WBV068000	60-68	2,8	M6	A RICHIESTA ON DEMAND
WBV072000	64-72	2,8	M6	A RICHIESTA ON DEMAND
WBV076000	68,5-76	2,8	M6	A RICHIESTA ON DEMAND
WBV080000	72,5-80	3,0	M6	A RICHIESTA ON DEMAND
WBV084000	76,5-84	3,0	M6	A RICHIESTA ON DEMAND
WBV088000	80-88	3,0	M6	A RICHIESTA ON DEMAND
WBV096000	88-96	3,0	M6	A RICHIESTA ON DEMAND
WBV100000	92-100	3,0	M6	A RICHIESTA ON DEMAND
WBV104000	95-104	3,0	M6	A RICHIESTA ON DEMAND
WBV108000	98-108	3,0	M6	A RICHIESTA ON DEMAND
WBV112000	103-112	3,0	M6	A RICHIESTA ON DEMAND
WBV116000	109-116	3,0	M6	A RICHIESTA ON DEMAND
WBV120000	111-120	3,0	M6	A RICHIESTA ON DEMAND
WBV124000	115-124	3,0	M6	A RICHIESTA ON DEMAND
WBV128000	120-128	3,0	M6	A RICHIESTA ON DEMAND
WBV132000	124-132	3,0	M6	A RICHIESTA ON DEMAND
WBV140000	125-140	3,0	M6	A RICHIESTA ON DEMAND
WBV150000	134-150	3,0	M6	A RICHIESTA ON DEMAND
WBV160000	145-160	3,0	M6	A RICHIESTA ON DEMAND
WBV165000	150-165	3,0	M6	A RICHIESTA ON DEMAND
WBV170000	155-170	3,0	M6	A RICHIESTA ON DEMAND
WBV180000	165-180	3,0	M6	A RICHIESTA ON DEMAND
WBV190000	175-190	3,0	M6	A RICHIESTA ON DEMAND

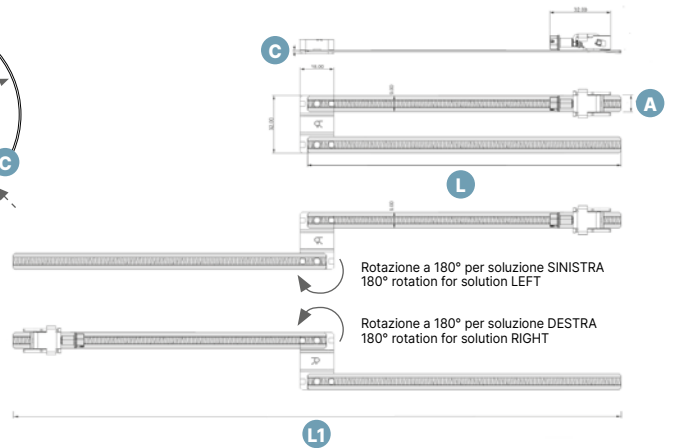
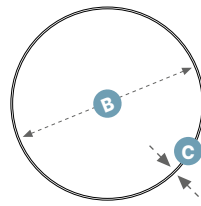

IMPIEGO APPLICATIONS

Industria in genere	Industry in general
Macchine agricole	Agriculture machine
Edilizia	Construction
Alimentare	Food



DESCRIZIONE DESCRIPTION

Rivoluzionaria fascetta per il serraggio del tubo spiralato, la fascetta SSS, grazie al nuovo sistema brevettato può essere utilizzata sia per tubi con spirale destrorsa che sinistrorsa. Effettuando l'operazione di rotazione sul perno centrale del ponticello di una delle due bande, l'operatore può ottenere la fascetta da utilizzare su tubo con spirale destra oppure sinistra. Inoltre, la banda zigrinata sull'intera lunghezza della fascetta permette di coprire un vasto range di diametri diminuendo drasticamente la gestione dei codici di approvvigionamento a magazzino. Infine, l'assenza di saldature, garantisce una performance eccellente di tenuta della fascetta.

Revolutionary hose clamp for the tightening of the spiral pipe, thanks to the new system patented it can be used for both the right and left spiral tubes. With the rotation operation on the central pin of the bridge by one of the two bands, the operator can obtain the band to be used on the tube with right or left spiral, moreover, the knurled band on the whole length of the band allows to cover a wide range of diameters drastically reducing the management of the codes to warehouse. Finally the absence of welding guarantees an excellent performance of Tightening torque.



MATERIALE MATERIAL

Banda Band	Acciaio inossidabile Stainless steel AISI 430
Cassetto Housing	Acciaio inossidabile Stainless steel AISI 430
Vite Screw	Acciaio zincato Zinc-plated steel

	LARG. NASTRO BAND WIDTH	DIAM. DIAM.	SPESSORE THICKNESS	LUNGHEZZA FASCETTA CHIUSA-APERTA LENGHT CLOSED LENGHT OPEN	COPPIA DI SERRAGGIO RACCOMANDATA RECOMMENDED TIGHTENING TORQUE	SCATOLE BOX
	A	B	C	L - L1	Nm	pz/nrm
	mm	mm	mm	mm		
WSS06013500000	9,0	60 - 135	0,6	211 - 425	3,5	25
WSS10017500000	9,0	100-175	0,6	274 - 550	3,5	25
WSS12522500000	9,0	125-225	0,6	355 - 710	3,5	25
WSS15828500000	9,0	158 - 285	0,6	450 - 900	3,5	25
WSS17531500000	9,0	175 - 315	0,6	500 - 1000	3,5	25
WSS19535000000	9,0	195 - 350	0,6	550 - 1100	3,5	25
WSS21338500000	9,0	213 - 385	0,6	610 - 1220	3,5	25
WSS24043500000	9,0	240 - 435	0,6	700 - 1400	3,5	25
WSS27048500000	9,0	270 - 485	0,6	775 - 1550	3,5	25
WSS29553500000	9,0	295 - 535	0,6	850 - 1700	3,5	25

CARATTERISTICHE FISICO MECCANICHE PHYSICAL AND MECHANICAL PROPERTIES

STRUTTURA Structure	Ferrit.
CARICO DI ROTTURA Breaking Load Rp 0,2 (N/mm ²) min	280
Rm (N/mm ²) min.	450-600
MODULO DI ELASTICITÀ A 20°C Elasticity in tensions at 20°C (kN/mm ²)	220
ALLUNGAMENTO Elongation (min)	20
COEFFICIENTE DI DILATAZIONE TERMICA Coefficient of thermal expansions 20 ÷ 200°C	10
CONDUTTIVITÀ TERMICA A 20°C Thermal conductivity at 20°C (W/m x K)	25
RESISTENZA ALLA CORROSIONE Corrosion resistance	PREN* 16.00 - 18.00

INFORMAZIONI TECNICHE TECHNICAL INFORMATION

TEMPERATURA DI ESERCIZIO Working temp.	-80°C to 538°C
INFIAMMABILITÀ Flammability	Ignifugo Fireproof
PROPRIETÀ ELETTROMAGNETICHE Electromagnetic prop.	Magnetico Magnetic
ALTRE Others	Resistente ai raggi UV UV resistant

TABELLA MATERIALI IN ACCORDO NORMA DIN 3017 E PRINCIPALI STANDARD INTERNAZIONALI TABLE OF MATERIALS ACCORDING TO DIN 3017 AND MAIN INTERNATIONAL STANDARDS

MATERIALE Material	ITALY UNI	DE WNDIN	UK B.S	FRANCE AFNOR	USA AISI-SAE
RESISTENZA NEBBIA SALINA Hour corrosion in salt spray (min.h)					72 H

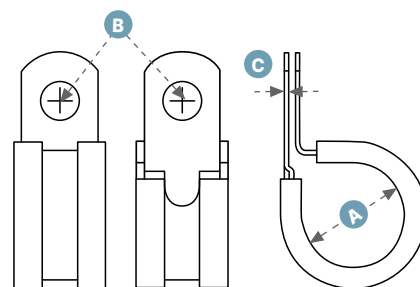

IMPIEGO APPLICATIONS

Industria in genere	Industry in general
Macchine agricole	Agriculture machine
Nautica	Marine
Automotive	Automotive



DESCRIZIONE DESCRIPTION

Realizzati in acciaio zincato sagomato e ricoperto in materiale antivibrante, per assicurare e garantire protezione ottimale dei cavi/tubi contenuti nei passacavi stessi e l'assorbimento di eventuali vibrazioni. Banda rinforzata in corrispondenza del foro d'attacco. Conforme alla normativa DIN 3016.

Reinforcement band and strip in shaped galvanized steel coated with anti-vibration rubber to ensure optimal protection of the cables/ pipes contained in the cable glands with the absorption of any vibrations. Manufactured according to DIN 3016.



MATERIALE MATERIAL

Banda Band	Acciaio zincato Zinc-plated steel
Rivestimento Coating	Gomma EPDM EPDM rubber

DIAM. DIAM.	FORO ATTACCO HOLE DIAM.	SPESSORE BANDE BAND THICKNESS	SCATOLE BOX
A	B	C	
mm	mm	mm	pz/nrm

15 mm

WCGC115006	6	6,4	0,6	100
WCGC115008	8	6,4	0,6	100
WCGC115010	10	6,4	0,6	100
WCGC115012	12	6,4	0,6	100
WCGC115014	14	6,4	0,6	100
WCGC115015	15	6,4	0,8	100
WCGC115016	16	6,4	0,8	100
WCGC115018	18	6,4	0,8	100
WCGC115020	20	6,4	0,8	100
WCGC115022	22	6,4	0,8	100
WCGC115024	24	6,4	0,8	100
WCGC115025	25	6,4	0,8	100
WCGC115028	28	6,4	0,8	100
WCGC115030	30	6,4	0,8	100
WCGC115032	32	6,4	0,8	100
WCGC115035	35	6,4	0,8	100
WCGC115038	38	6,4	0,8	100
WCGC115040	40	6,4	0,8	100

20 mm

WCGC120010	10	8,4	0,8	50
WCGC120011	11	8,4	0,8	50
WCGC120012	12	8,4	0,8	50
WCGC120013	13	8,4	0,8	50
WCGC120014	14	8,4	0,8	50
WCGC120015	15	8,4	0,8	50
WCGC120016	16	8,4	0,8	50
WCGC120017	17	8,4	0,8	50
WCGC120018	18	8,4	0,8	50
WCGC120020	20	8,4	0,8	50
WCGC120022	22	8,4	0,8	50
WCGC120024	24	8,4	0,8	50
WCGC120025	25	8,4	0,8	50
WCGC120026	26	8,4	1,0	50
WCGC120028	28	8,4	1,0	50
WCGC120030	30	8,4	1,0	50
WCGC120032	32	8,4	1,0	50
WCGC120034	34	8,4	1,0	50
WCGC120035	35	8,4	1,0	50
WCGC120036	36	8,4	1,0	50
WCGC120038	38	8,4	1,0	50
WCGC120040	40	8,4	1,0	50
WCGC120042	42	8,4	1,0	50
WCGC120044	44	8,4	1,0	50
WCGC120046	46	8,4	1,0	50
WCGC120048	48	8,4	1,0	50
WCGC120050	50	8,4	1,0	50
WCGC120052	52	8,4	1,0	50
WCGC120054	54	8,4	1,0	50
WCGC120056	56	8,4	1,0	50
WCGC120058	58	8,4	1,0	50
WCGC120060	60	8,4	1,0	50
WCGC120062	62	8,4	1,0	50

SNA

NASTRI BANDI-BLOCK
BANDS BANDI-BLOCK

Realizzati in acciaio austenitico, in rotoli da 30 e 50 m confezionati in scatole di cartone.
Austenitic stainless steel Bands in 30 and 50 m rolls, packed in stout cardboard box.



Industria in genere	Industry in general
Irrigazione	Irrigation
Nautica	Marine
Petrochimica	Petrochemical

MATERIALE MATERIAL	CODICE CODE	LARGHEZZA WIDTH ↔	SPESORE THICKNESS ↕	CARICO MEDIO DI ROTTURA AVERAGE BREAKING STRENGTH ↓	SCATOLE BOX 📦	PESO WEIGHT KG
		mm	mm	kg	mt/cad	kg/cad
Acciaio inox Stainless steel AISI 201	WNA095201	9,50	0,65	410	30	1,5
	WNA127201	12,70	0,75	680	30	2,3
	WNA158201	15,80	0,75	850	30	2,9
	WNA195201	19,05	0,75	1020	30	3,5
Acciaio inox Stainless steel AISI 304	WNA095304	9,50	0,65	390	30	1,5
	WNA127304	12,70	0,75	500	30	2,3
	WNA158304	15,80	0,75	650	30	2,9
	WNA195304	19,05	0,75	950	30	3,5
Acciaio inox Stainless steel AISI 316	WNA095316	9,50	0,65	340	30	1,5
	WNA127316	12,70	0,75	540	30	2,3
	WNA158316	15,80	0,75	680	30	2,9
	WNA195316	19,05	0,75	820	30	3,5

SNG

GRAFFE BANDI-BLOCK
BUCKLES BANDI-BLOCK

Realizzate in acciaio inox austenitico, confezionate in scatole di cartone da 100 pz.
Austenitic stainless steel Buckles, packed in cardboard box of 100 pieces.



MATERIALE MATERIAL	CODICE CODE	LARGHEZZA WIDTH ↔	PER NASTRI FOR BAND	CARICO MEDIO DI ROTTURA AVERAGE BREAKING STRENGTH ↓	SCATOLE BOX 📦	PESO WEIGHT KG
		mm		kg	mt/cad	kg/cad
Acciaio inox Stainless steel AISI 304	WNG095304	9,50	AISI 201	390	100	0,5
	WNG127304	12,70	AISI 201	500	100	1,0
	WNG158304	15,80	AISI 201	650	100	1,3
	WNG195304	19,05	AISI 201	950	100	1,6
Acciaio inox Stainless steel AISI 316	WNG095316	9,50	AISI 316	340	100	0,5
	WNG127316	12,70	AISI 316	540	100	1,0
	WNG158316	15,80	AISI 316	680	100	1,3
	WNG195316	19,05	AISI 316	820	100	1,6

SNU

UTENSILE MANUALE
TOOL BANDI-BLOCK

Con questo utensile si può eseguire l'installazione completa, cioè il fissaggio con trazione ed il taglio della parte eccedente del nastro.

The tool allows for the full installation, that is fixing by pulling and cutting band exceeding part.



CODICE CODE	PER NASTRI FOR BAND	SCATOLE BOX 📦	PESO WEIGHT KG
		pz/cad	kg/cad
WNU001	AISI 201 AISI 304 AISI 316	1	2,0

BELTS DIVISION

RUBBER CONVEYOR BELTS



 **SATIBELT**

 **SATIVERTICAL**

SHEETS DIVISION

RUBBER SHEETS AND FOAM



 **SATISHEET**

 **SATIFOAM**

HOSES DIVISION

RUBBER AND PVC HOSES



 **SATIHOSE**

 **SATIHOSE**

MARINE

 **SATIBLOCK**



- **INTERA GAMMA PRODOTTI**
FULL PRODUCT RANGE
- **SCHEDE TECNICHE**
TECHNICAL DATA SHEETS
- **SOLUZIONI PER SETTORE**
SECTORS SOLUTIONS
- **NOVITÀ**
NEWS

VISIT OUR WEBSITE

www.satigroup.it





SATI GROUP S.P.A.

Via Bonazzi, 24
40013 Castel Maggiore
Bologna - Italy
T +39 051 700321
www.satigroup.it

Ufficio Vendite Italia
commerciale@satigroup.it

Sales Export Department
export@satigroup.it

P. IVA 00672251204